

Liebherr Material Handling Machines **for Port Applications**



LIEBHERR

Material Handling Machines for Port Applications





Liebherr has a wide-ranging portfolio of handling machines which are powerful solutions for handling bulk and piece goods quickly and efficiently.

An extensive product range is available to meet a very wide range of requirements. Depending on its type of use, each machine can be configured individually using a selection of undercarriage versions, equipment combinations, grabs and quick coupling systems.

Long reaches, high load capacities and outstanding stability are some of the main characteristics of Liebherr handling machines. Excellent construction and a new, lightweight equipment design ensure that the machines will operate efficiently and deliver maximum performance with minimal costs per tonne of material.



The overall design approach enables the engine, hydraulic and electronic components to be coordinated perfectly, ensuring precision control with uniform high performance.



Material Handling Machines Overview

Equipment

- High lift capacities and long reaches thanks to weight-optimised design for more handling capacity
- Energy recovery cylinder filled with nitrogen for maximum efficiency, less fuel consumption at more handling capacity
- Pipe fracture safety valves on hoist and stick cylinders and retract stick shut-off for maximum safety during every application
- Electro-hydraulic end position control extends the service life of the components
- Quick coupling systems and attachments made by Liebherr for maximum machine utilisation and greater handling performance

Operator's Cab

- Hydraulic cab elevations for always the best view downwards as well as forwards
- Less strain on the operator, workers and reduced environmental pollution due to lower noise emissions
- Optimum visibility thanks to large glass surfaces and standard rear and side area monitoring with camera
- Joystick steering without steering column as standard for convenient operation, greater legroom and clear view of the working area at mobile undercarriage
- Proportional control as standard with 4-way minijoystick for greater precision, highprecision control and functions





Uppercarriage

- 2-circuit Liebherr-Synchron-Comfort-Hydraulicsystem (LSC) with LUDV technology for faster working speed at minimum fuel consumption
- High engine output and high pump flow for fast work cycles, convincing dynamics and maximum handling performance
- Electrical pilot control enables individual settings for the operator and new options such as load torque limitation
- Reduction in operating costs thanks to built-in maintenance advantages and optimum service accessibility
- Optimised hydraulics with closed slewing mechanism circuit for greater fuel efficiency and faster work cycles

Undercarriage

- Mobile undercarriage central lubrication system, manual or automatic options, for enhanced productivity and machine availability
- Large footprint for high stability and maximum lift capacities
- Variety of undercarriage options available for different applications
- Ergonomic, durable access system with non-slip catwalks to ensure a safe access and exit

The Perfect Solution for Every Application

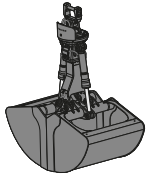

Clamshell Grab



Multi-Tine Grab



Wood Grab

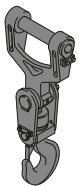

Load Hook

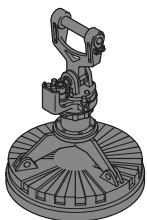

Magnet Devices

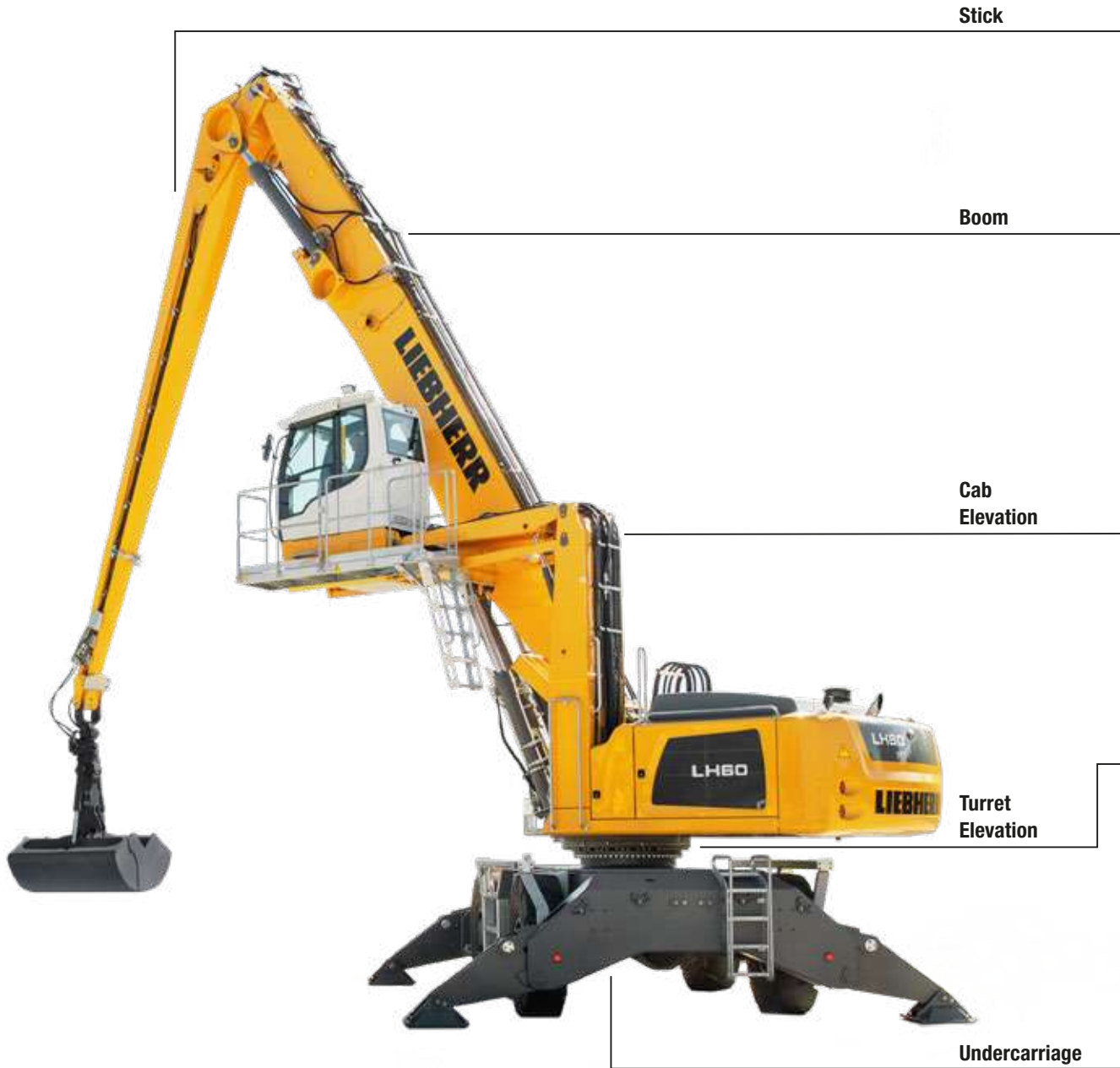

Stick

Boom

Cab
Elevation

Turret
Elevation

Undercarriage

Possible Configurations		LH 40	LH 50	LH 60	LH 80	LH 110	LH 150
Straight		✓	✓	✓	✓	✓	✓
Straight		✓	✓	✓	✓	✓	✓
Angled		✓	✓	✓	✓	✓	✓
Hydraulic		✓	✓	✓	✓	✓	✓
Rigid		✓	✓	✓	✓	✓	✓
High Rise			✓	✓	✓	✓	✓
Mobile		✓	✓	✓	✓	✓	✓
Crawler		✓	✓	✓	✓	✓	✓
Gantry (Crawler, Track)					✓	✓	✓

Handling Machines Product Range

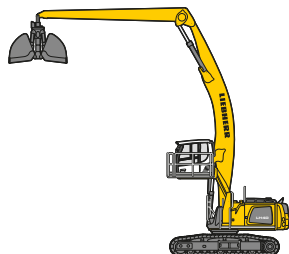

LH 40 C Port Litronic

LH 40 Port

Variants: M/C

Operating weight¹: 41–50 t

Reach: 18 m

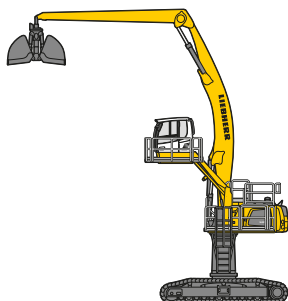

LH 50 C HR Port Litronic

LH 50 Port

Variants: M HR/C HR

Operating weight¹: 46–56 t

Reach: 19 m

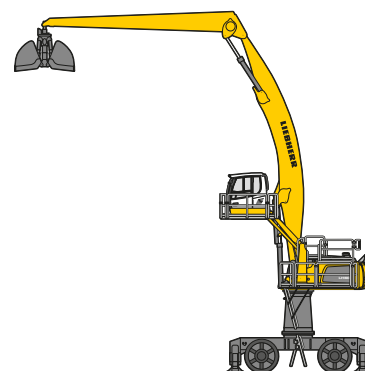

LH 60 M HR Port Litronic

LH 60 Port

Variants: M/M HR/C/C HR

Operating weight¹: 60–77 t

Reach: 23 m



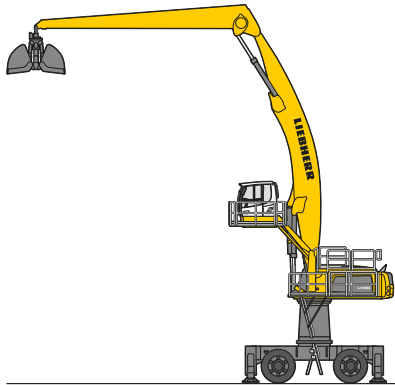

LH 80 M HR Port Litronic

LH 80 Port

Variants: M/M HR/C/C HR/C G
 Operating weight¹: 76–117 t
 Reach: 25 m

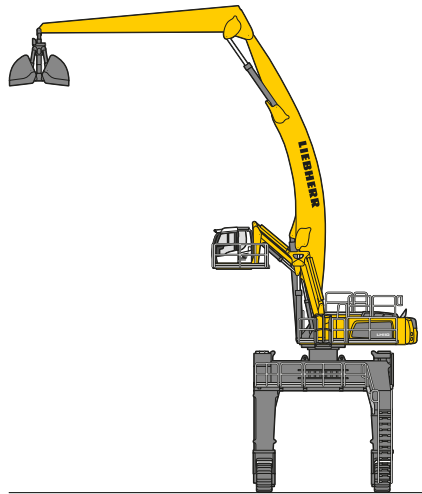

LH 110 C G Port Litronic

LH 110 Port

Variants: M/M HR/C/C HR/C G
 Operating weight¹: 100–140 t
 Reach: 27 m

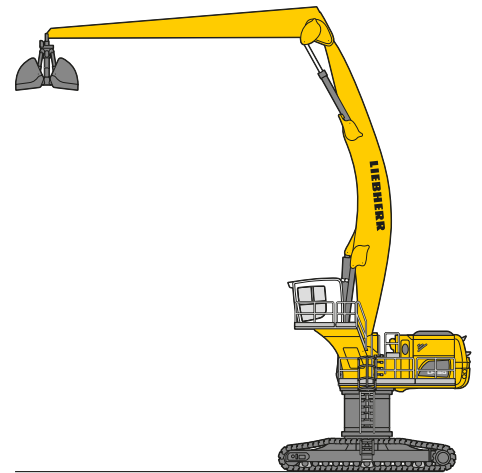

LH 150 C HR Port Litronic

LH 150 Port

Variants: M/M HR/C/C HR/C G
 Operating weight¹: 130–220 t
 Reach: 31 m



M = Mobile
 C = Crawler
 M HR = Mobile High Rise
 C HR = Crawler High Rise
 C G = Crawler Gantry
¹ Without attachment

The drawings are simplified and some of them also shown in mirror image form. They may therefore differ from the original machines.

The Perfect Handling Machine for all Port Applications

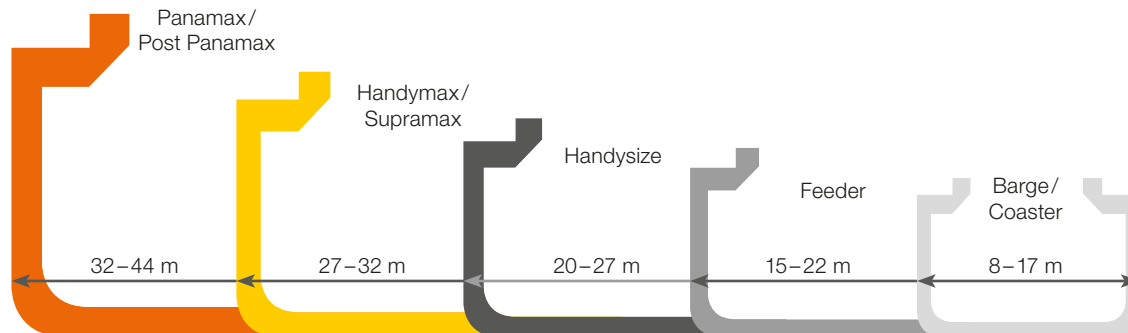
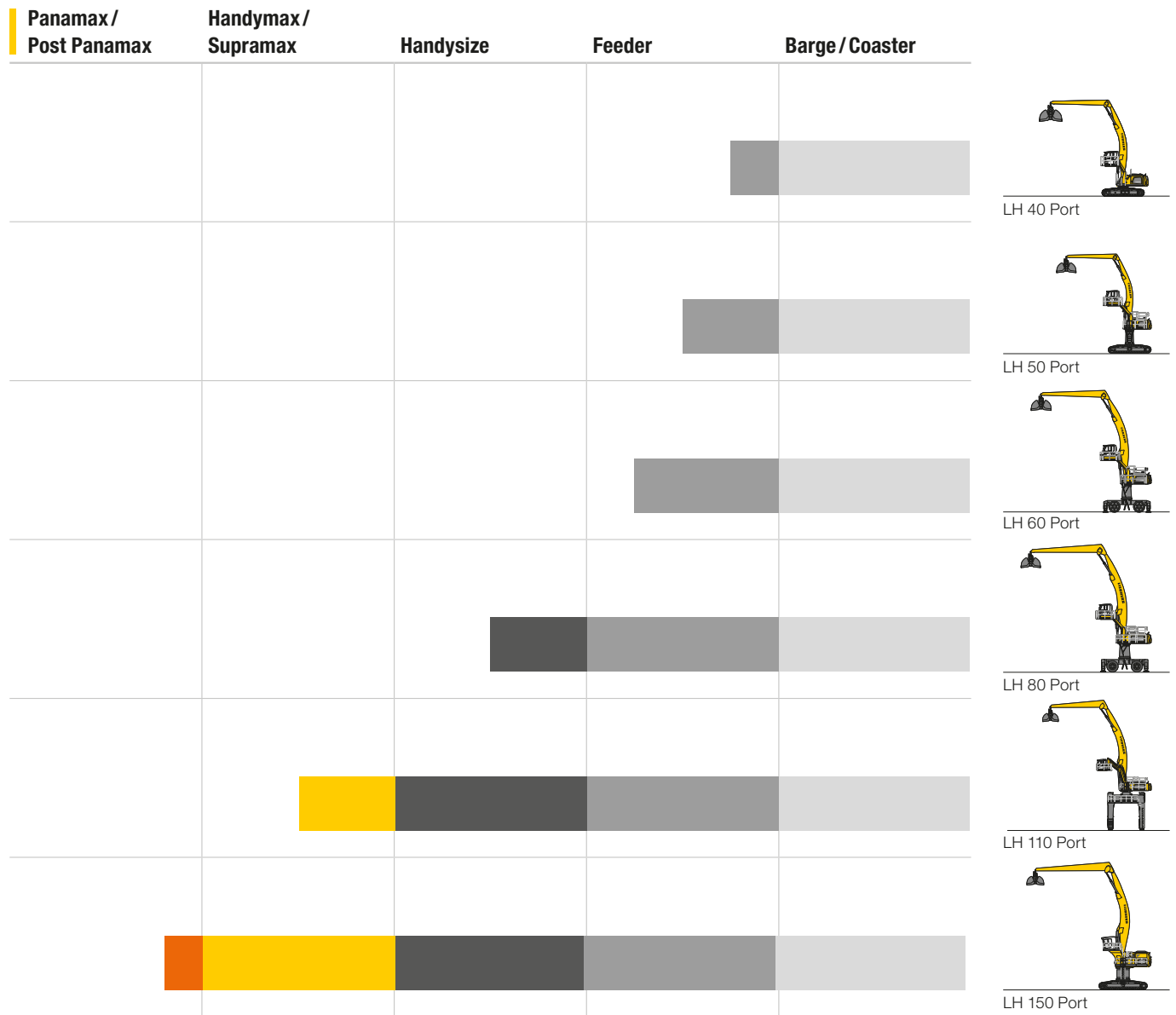

Cycles per Hour:

Unloading: 70 – 90, Loading: 80 – 100

400 t/h 520 t/h	400 t/h 500 t/h	320 t/h 400 t/h	250 t/h 320 t/h	120 t/h 150 t/h
400 t/h 520 t/h	400 t/h 500 t/h	320 t/h 400 t/h	250 t/h 320 t/h	120 t/h 150 t/h
500 t/h 620 t/h	600 t/h 750 t/h	440 t/h 560 t/h	380 t/h 480 t/h	200 t/h 250 t/h
560 t/h 700 t/h	700 t/h 850 t/h	580 t/h 720 t/h	450 t/h 560 t/h	240 t/h 300 t/h
700 t/h 900 t/h	800 t/h 1,000 t/h	700 t/h 880 t/h	640 t/h 800 t/h	320 t/h 400 t/h
800 t/h 1,000 t/h	1,000 t/h 1,200 t/h	900 t/h 1,100 t/h	760 t/h 960 t/h	400 t/h 500 t/h



page 12

LH 40 Port



page 14

LH 50 Port



page 16

LH 60 Port



page 18

LH 80 Port



page 20

LH 110 Port



page 22

LH 150 Port



Wood
5.0 m (Length)
0.8 t/m³

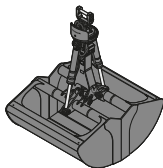

Loose Material
2.5 t/m³

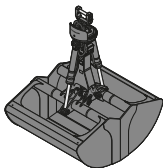

Loose Material
1.6 t/m³

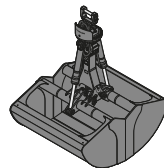

Loose Material
0.8 t/m³

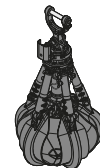

Light Metals
0.5 t/m³

The handling performance figures shown in the table are guide values for selecting the perfect Liebherr handling machine for specific applications, and in practice depend on a range of factors. Among other things, the actual handling performance is influenced by local conditions (position and size of the vessel) and the selection of the attachment (this may be very significant for certain materials).

LH 40 Port

Litronic®

Technical Data

Operating weight*	41,100 – 50,300 kg	
Engine output	155 kW/211 HP	
Emission stage	Stage V	Stage IIIA (compliant)
System performance	233 kW	
Reach	18 m	

* Without Attachment

For further information go to:



Application Example

LH 40 M – Equipment AG 17

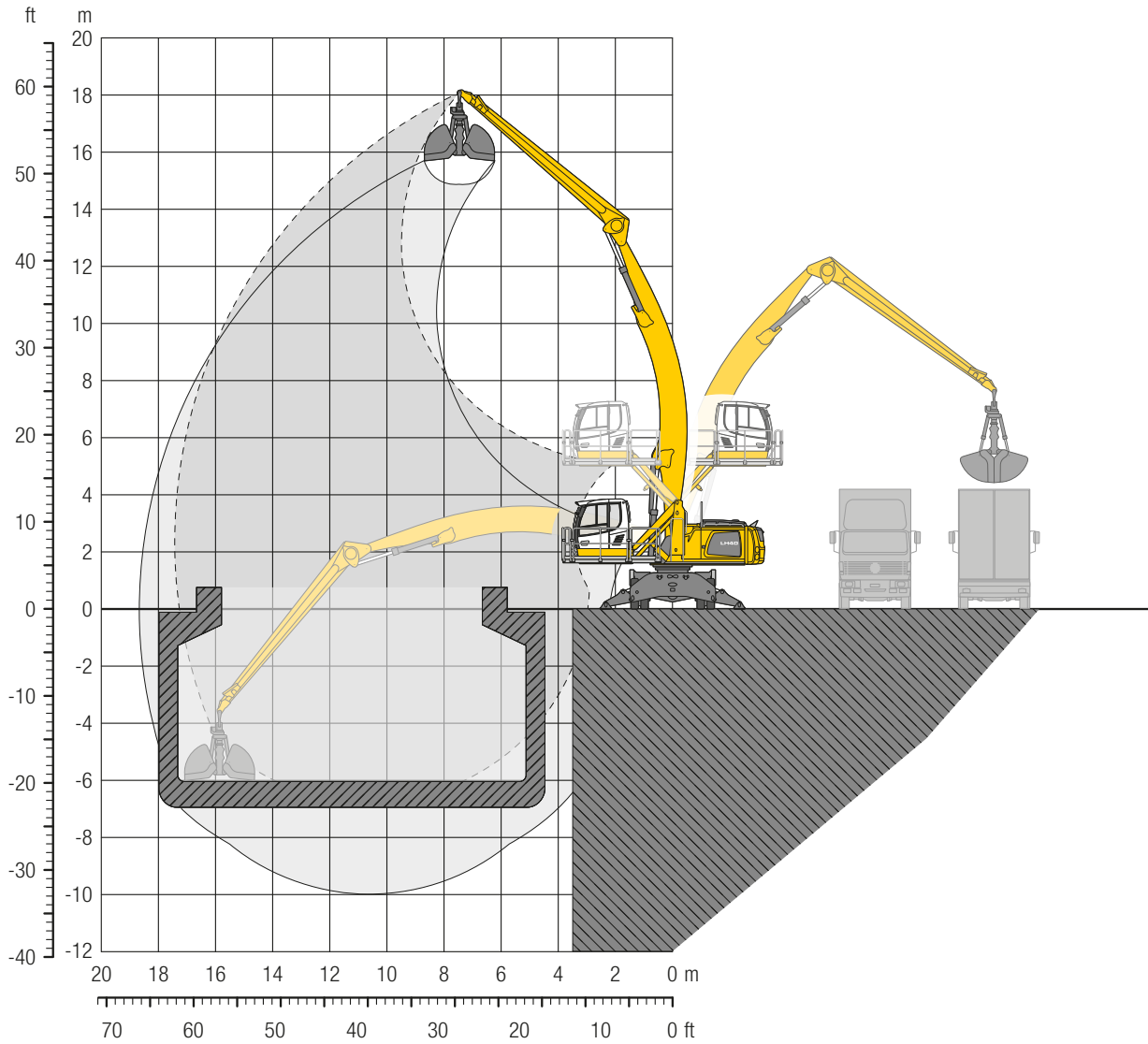

Variants

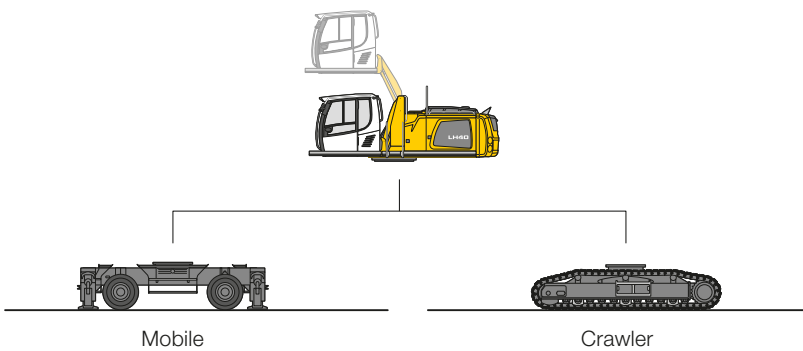

LH 50 High Rise Port

Litronic®

Technical Data

Operating weight *	46,000 – 56,000 kg	
Engine output	155 kW / 211 HP	
Emission stage	Stage V	Stage IIIA (compliant)
System performance	233 kW	
Reach	19 m	

* Without Attachment

For further
information go to:



Application Example

LH 50 M HR – Equipment AG 18

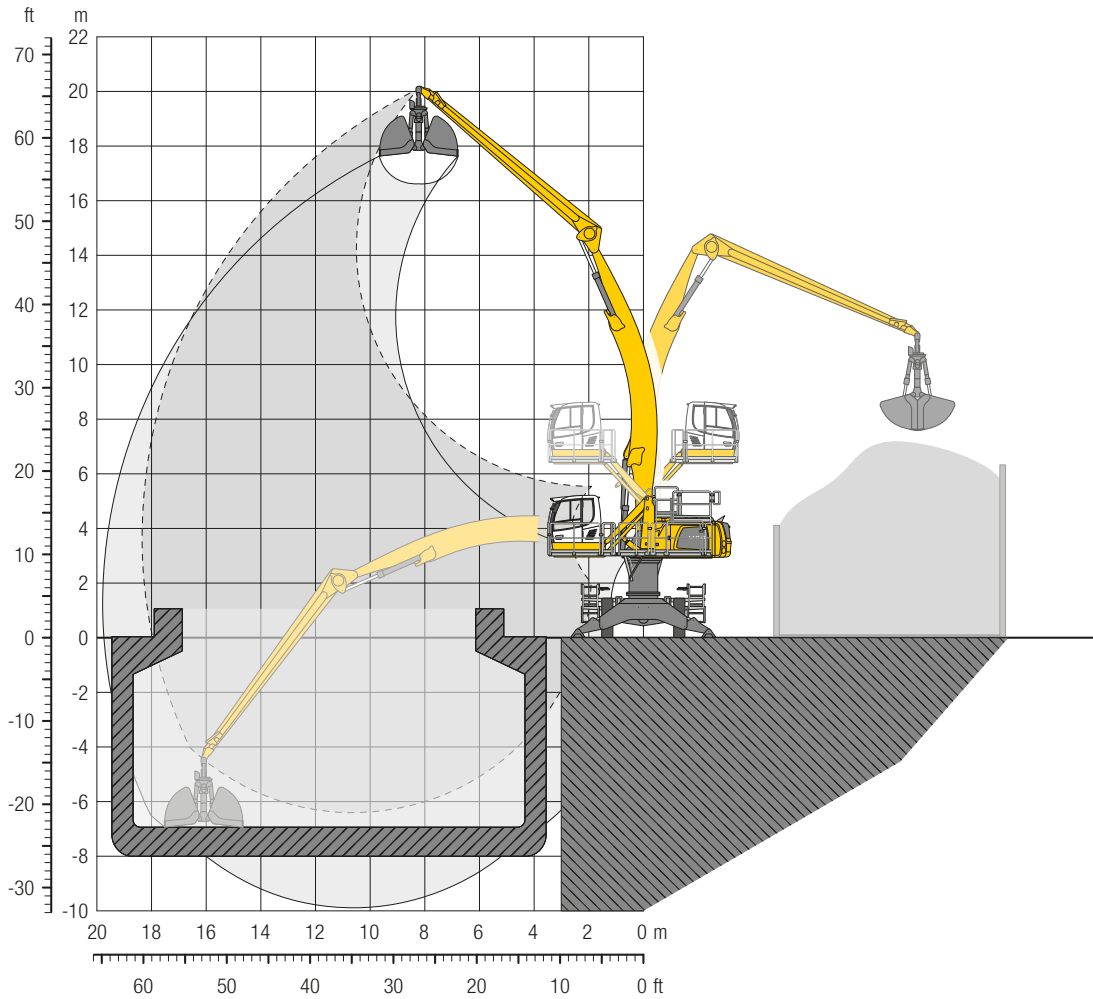

Variants

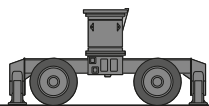
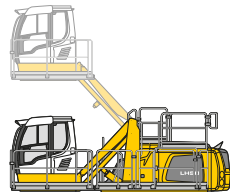

Mobile

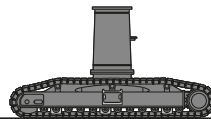

Crawler

LH 60 Port

Litronic®

Technical Data

Operating weight*	59,900 – 77,300 kg	
Engine output	190 kW / 258 HP	
Emission stage	Stage V	Stage IIIA (compliant)
System performance	322 kW	
Reach	23 m	

* Without Attachment

For further information go to:



Application Example

LH 60 C – Equipment AG 20

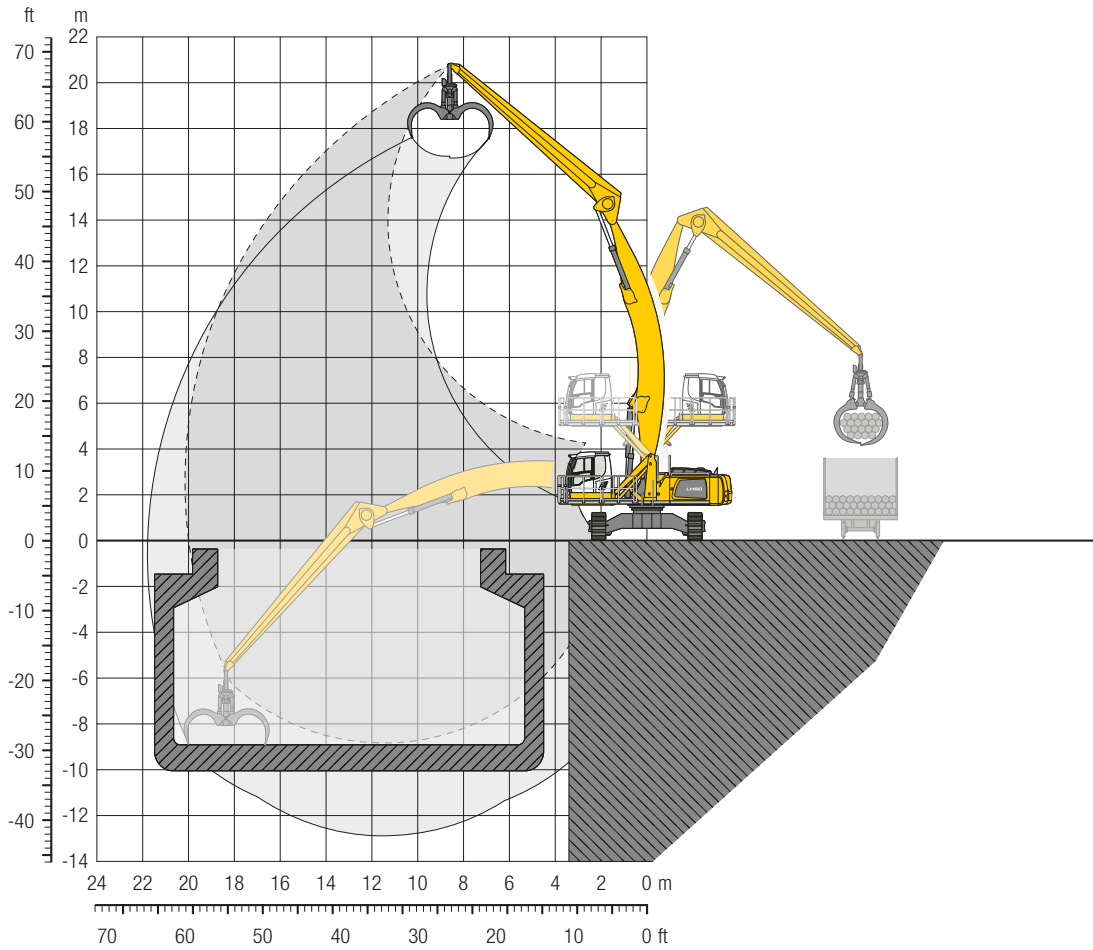

Variants

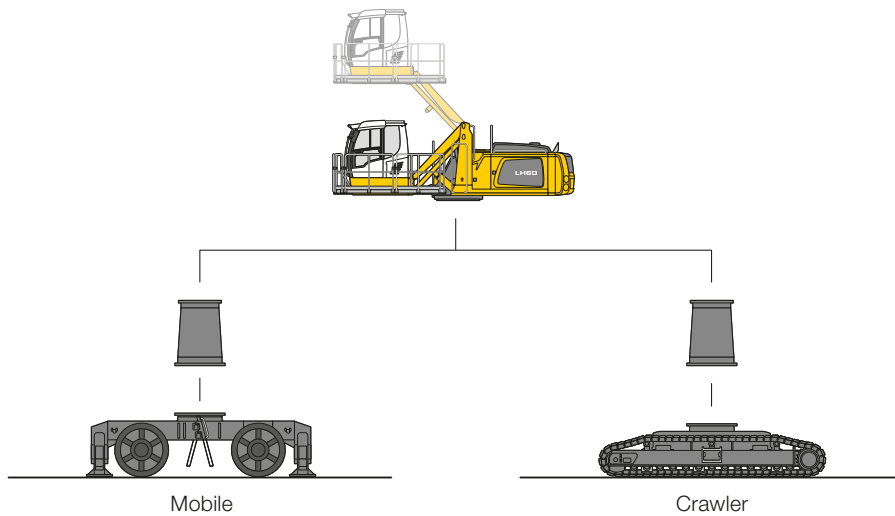

LH 80 Port

Litronic®

Technical Data

Operating weight*	75,700 – 116,700 kg	
Engine output	230 kW/313 HP	
Emission stage	Stage V	Stage IIIA (compliant)
System performance	418 kW	
Reach	25 m	

* Without Attachment

For further information go to:



Application Example

LH 80 M HR – Equipment AG 24

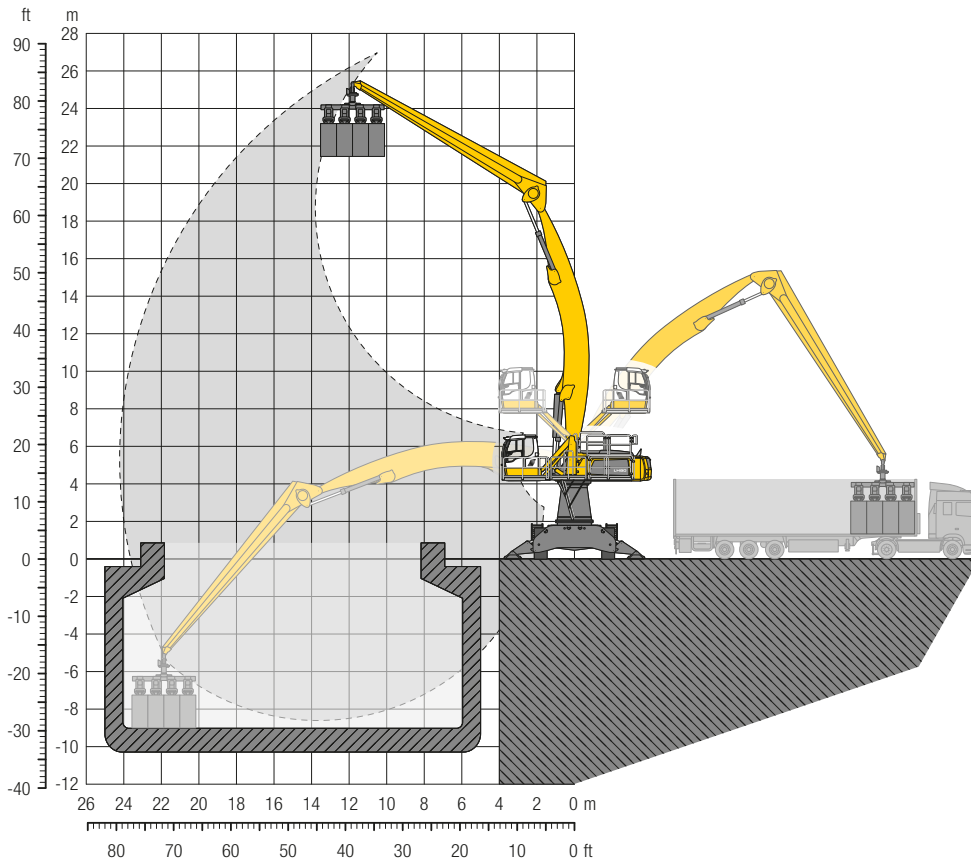

Variants

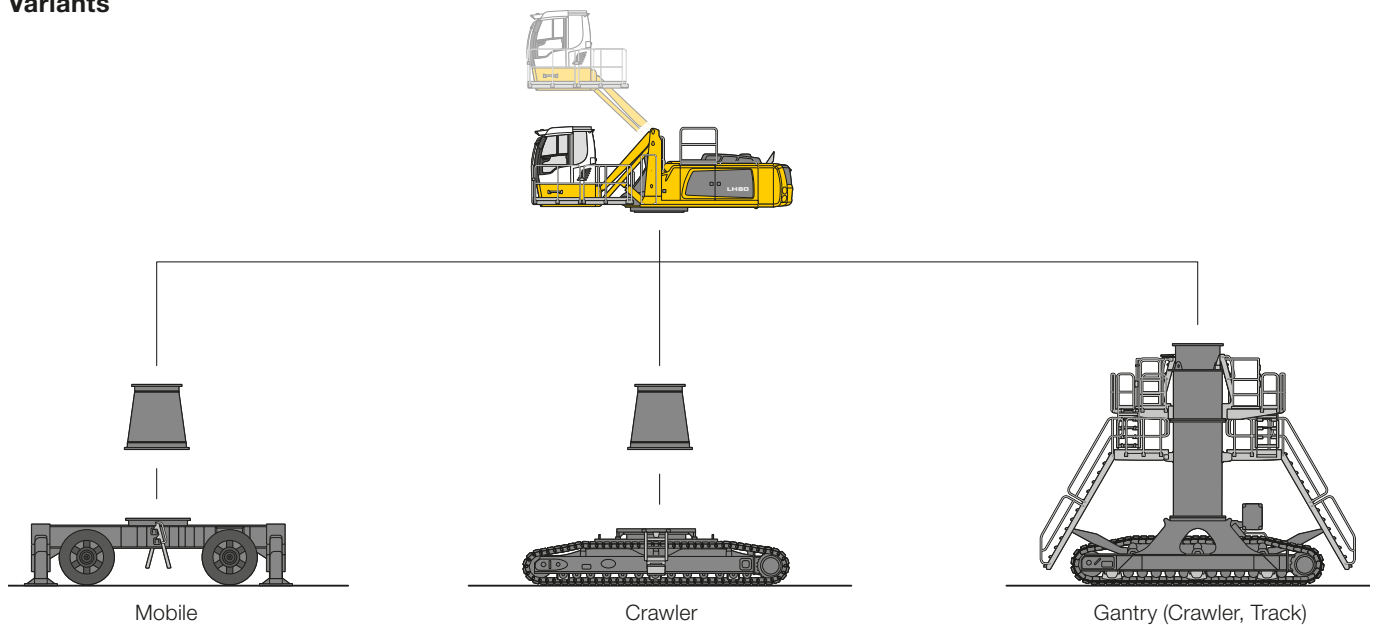

LH 110 Port

Litronic®

For further information go to:



Technical Data

Operating weight*	100,000 – 140,000 kg	
Engine output	300 kW / 408 HP	
Emission stage	Stage V	Stage IIIA (compliant)
System performance	478 kW	
Reach	27 m	

* Without Attachment



Application Example

LH 110 C Gantry – Equipment AG 27

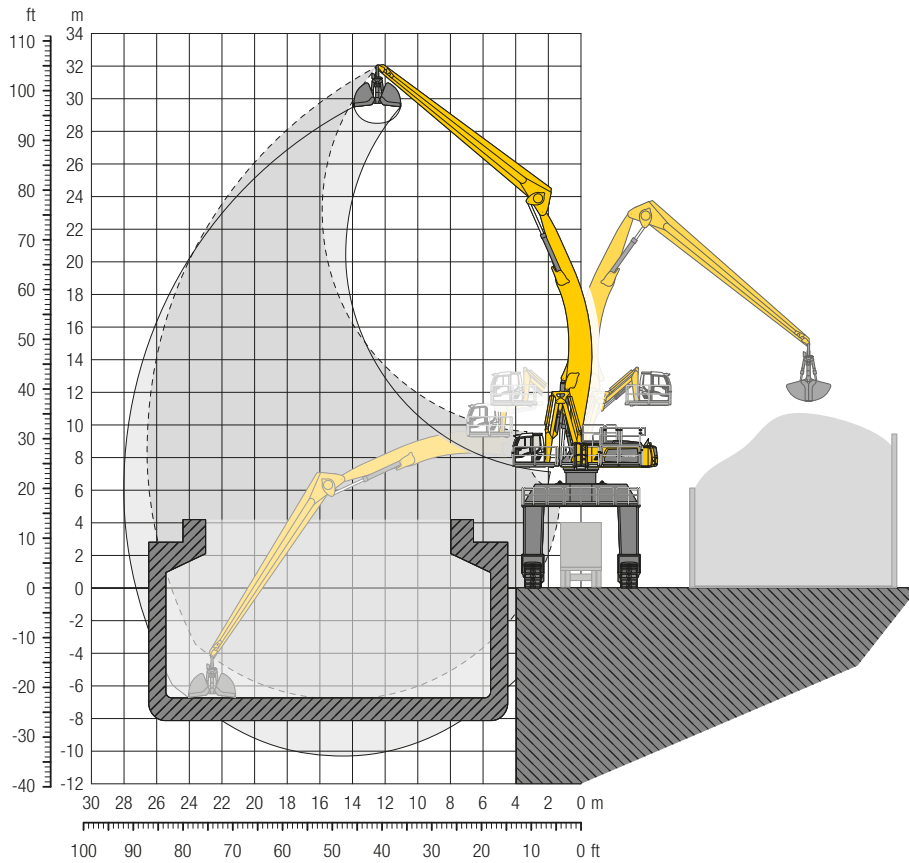

Variants

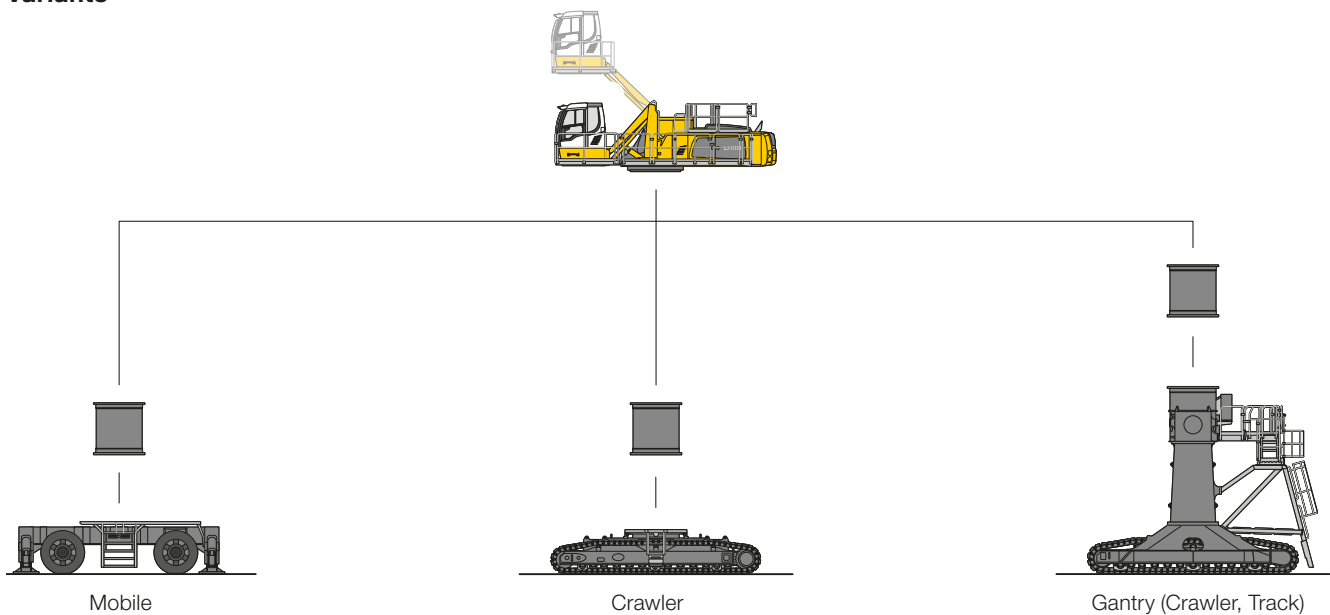

LH 150 Port

Litronic®

For further information go to:



Technical Data

Operating weight*	130,000 – 220,000 kg	
Engine output	400 kW / 543 HP	
Emission stage	Stage V	Stage IIIA (compliant)
System performance	614 kW	
Reach	31 m	

* Without Attachment



Application Example

LH 150 C Track Gantry – Equipment AG 31

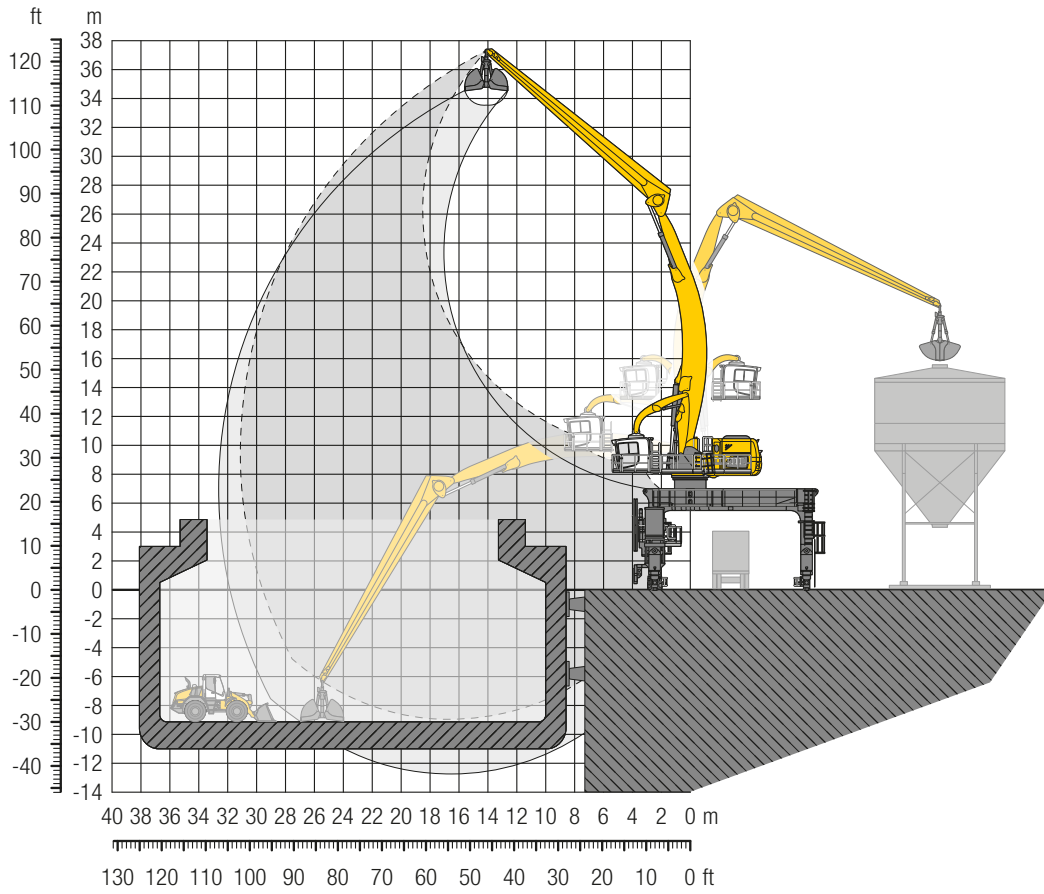

Variants

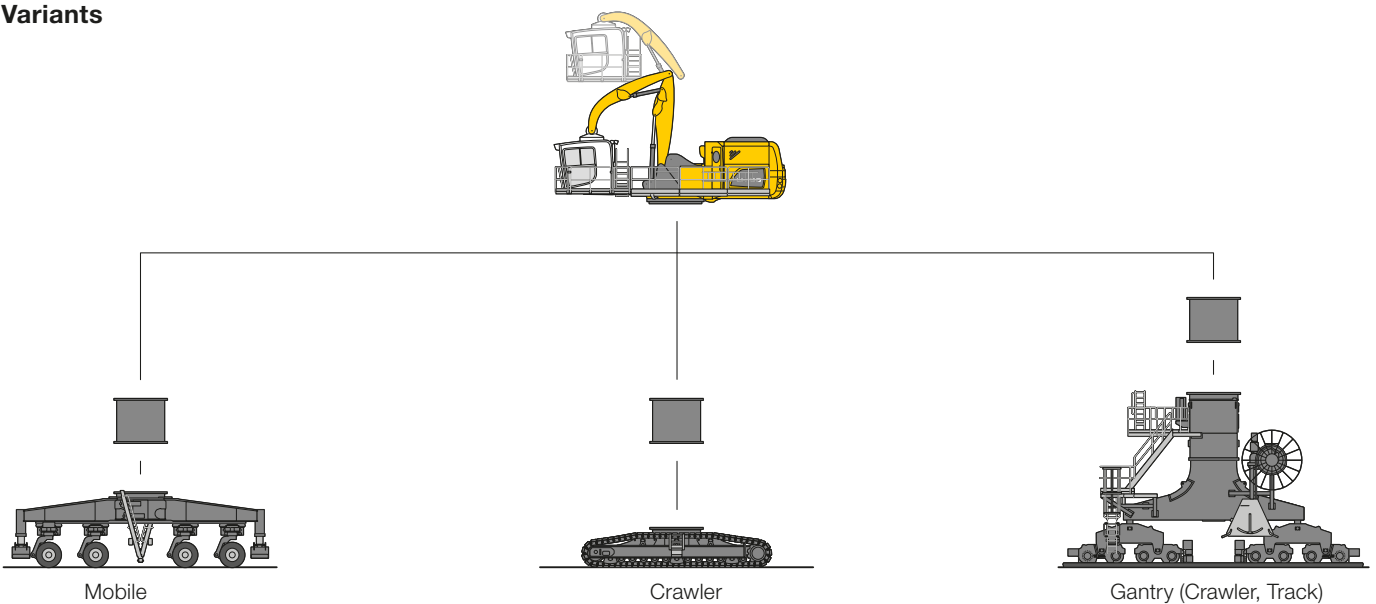

Attachments and Quick Coupling Systems

Liebherr develops and manufactures a wide range of attachments whose design, properties and technical equipment make them ideal for economical handling work at port locations.

The extensive range includes grabs for bulk goods, timber and light metal, load hooks, magnet devices and lifting magnets for handling piece goods. Each tool is available with a wide range of versions, shapes and features to handle a wide range of materials safely and quickly with maximum productivity. Experience from practice and continuous advanced development ensure that Liebherr attachments are always state of the art.

Liebherr can supply quick coupling systems suitable for handling goods at ports to increase productivity, efficiency and safety. The machine, quick coupling system and attachment form an efficient unit to deliver maximum economy.

MH 40B LIKUFIX/MH 110B LIKUFIX is a fully automatic coupling system for mechanical, hydraulic and electrical connections. Based on LIKUFIX technology, it is ideal for changing suspended attachments such as clamshell grabs, multiple tine grabs, wood grabs, magnet devices, load hooks or traverses in a matter of seconds without leaving the cab. During the coupling process, all hydraulic and electrical lines (up to 13 kW on the MH 40B/up to 30 kW on the MH 110B) are connected or disconnected. The top section of the machine is fitted with an integral swivel circuit and can be used for any number of attachments with a bottom section (without a swivel circuit). This means that there is no need for a suspension and swivel drive for any other attachment. An optional deflector prevents damage to the MH 110B LIKUFIX quick coupling system, particularly when unloading ships

Either the MH 40B LIKUFIX or the MH 110B LIKUFIX can be installed on all Liebherr material handling machines depending on their size. This quick coupling system increases the flexibility, productivity and economy of the carrier machine enormously.



For further information go to:



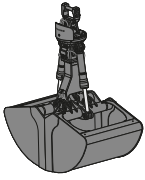

Clamshell Grab

Clamshell grabs are designed for loading and unloading skips, railway wagons or cargo holds. A wide range of bulk goods such as ore, coal, sand, gravel or grain can be handled safely and quickly using clamshell grabs.

GMZ 40	Shells for Loose Material	1.20 – 3.50 m ³
GMZ 50	Shells for Loose Material	3.50 – 8.00 m ³
GMZ 80	Shells for Loose Material	3.00 – 8.00 m ³
GMZ 120	Shells for Loose Material	4.00 – 10.00 m ³



Multi-Tine Grab

Light metal can be handled at ports using multiple tine grabs. Five-tine grabs with a closed tines form are available for this purpose.

GM 70C	5 Tines, closed	0.80 – 1.10 m ³
GMM 80-5	5 Tines, closed, Heart-Shaped	1.10 – 1.70 m ³
GMM 120-5	5 Tines, closed	1.70 – 3.00 m ³



Wood Grab

Wood grabs are designed to pick up a wide range of log quantities and types and move them efficiently.

GM 20B	Round-Shaped	1.00 – 1.90 m ²
GMH 50	Round-Shaped	2.50 – 3.60 m ²
GMH 50	Heart-Shaped	2.20 – 3.60 m ²
GMH 80	Round-Shaped	1.60 – 2.50 m ²
GMH 120	Round-Shaped	2.80 – 3.20 m ²
GMH 120	Round-Shaped, Two over One Tong	1.40 m ²

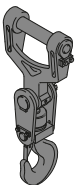

Load Hook

Load hooks with maximum attachment loads of 12.5 t to 25 t are available for handling piece goods safely.

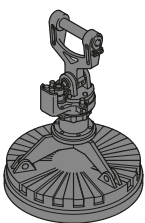

Magnet Devices / Lifting Magnets

Magnet devices and lifting magnets have a rating of 8.8 kW to 22 kW.

Performance

Maximum Handling Capacity

High load capacities, short cycle times and covering a wide working area are the main factors for making the handling of bulk and piece goods both efficient and successful. Liebherr's wide product range contains perfect solutions for the smooth handling of goods at sea and inland waterway ports.

The new equipment, specially designed for handling bulk and piece goods, delivers enormous load capacities. When combined with the well designed support geometry, they deliver maximum stability, which therefore results in above average handling capacity.

Excellent Reach

With reaches from 13 to over 31 m, the material handling machines cover a very wide range of work and can be used for loading and unloading ships up to Panamax size.



Equipment

- Weight-optimised design for greatest load capacities
- Large working area created by a reach of up to 31 m
- Electro-hydraulic end position control prolongs service life of components
- Quick coupling system guarantees maximum flexibility

Closed Slewing Circuit

- High torque for maximum acceleration and fast rotary movements
- Integrated speed sensor for controlling and monitoring braking movement for greater safety
- Greater fuel efficiency thanks to intelligent energy management in the closed system

Liebherr Engine Technology

- Powerful, robust and reliable
- Maximum torque even at low speeds to ensure fast movements with low fuel consumption
- Common-Rail injection system for maximum efficiency in Liebherr diesel engines
- The very latest engine technology developed and manufactured by Liebherr

Economy

Increased Productivity

The new generation of material handling machines is both powerful and efficient. Liebherr manages to achieve this difficult balancing act by using its own sophisticated engine technology and improved demand-controlled hydraulics.

Liebherr uses the very latest engine technology with smart machine control systems to improve the interaction of the drive components to enhance efficiency. When combined with Liebherr's standard, innovative energy recovery system, fuel consumption is reduced to a minimum whilst handling capacity is significantly increased by faster, more homogeneous work cycles – delivering lower consumption and greater efficiency along with maximum performance.

Fuel Efficiency

The closed slewing circuit feeds the braking energy back into the system when the uppercarriage is braked. Here, new standards are set in terms of efficiency and economy. Simple yet effective.

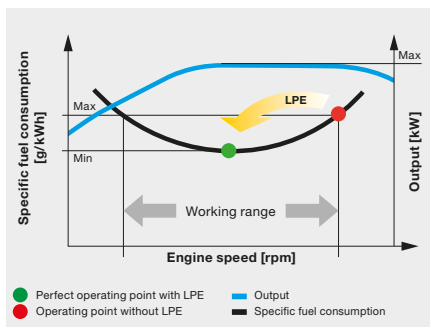

Low Fuel Consumption Thanks to Intelligent Machine Control

- Liebherr-Power Efficiency (LPE) optimises the interaction of the drive components in terms of efficiency
- LPE enables machine operation in the area of the lowest specific fuel use for less consumption and greater efficiency with the same performance

Liebherr – Energy Recovery System ERC

- Increased total power
- Higher handling capacity
- Fuel savings of up to 30 %
- Lower running costs
- Reduced pollutant and noise emissions

Liebherr Attachments

- Robust and service-friendly slewing drive, can be turned 360°
- Optimum filling and clamping performance for effective material handling
- Finite element method (FEM) optimised for a perfect relationship between grab weight, volume and a very long service life

Reliability

Quality and Competence

Our experience, understanding of customer needs and the technical implementation of these findings guarantee the success of the product. For decades, Liebherr has been inspirational with its depth of production and system solutions. Key components such as the diesel engine and electric motors, electronic components, slew ring, slew drives and hydraulic cylinders are developed and produced by Liebherr itself. The extend of in-house manufacturing guarantees maximum quality and ensures that components are optimally configured to each other.

High Safety

Safety equipment, such as an optional working range limit, which effectively prevents damage to the ship caused by accidental contact between the limit of the reach and depth. Furthermore, the operator is actively supported in manoeuvring the machine safely within the maximum load capacity range by the load moment limiting system. This means that the working range and load moment limiting systems deliver the best possible safety for handling bulk and piece goods.



QPDM – Quality and Process Data Management

- QPDM allows production data to be logged, documented and evaluated
- Test specifications and machine documented automatically logged
- Ability to handle large quantities of data while maintaining uniform high quality

Piston Rod Protection

- Maximum protection of piston rod
- Robust construction of hot-dip galvanised steel for a long service life in tough applications
- Available for outriggers, hoist cylinders and ERC cylinder

Stability

- The counterweight in the base unit is tailored to the special operating conditions
- The optimised weight distribution between the uppercarriage, undercarriage and equipment ensures stability with maximum load capacity

Comfort

Deluxe Cab

The newly developed Liebherr operator's cab gives machine operators the space and comfort they need to fully exploit the capacity of the machines. Large areas of glass, different cab elevation versions as well as rear and side area monitoring systems provide operators with a perfect view of their working area and the zone around the machine.

Comfortable Operation

The Comfort operator's seat, the intuitive colour touchscreen display, the standard proportional control system and joystick steering enable operators to control the material handling machine comfortably and precisely. Furthermore, automatic central lubrication systems for the machine and attachment deliver the comfort required to enable the operator to concentrate on the essential – handling capacity.



Liebherr Double Link Cab

- Always the best view upwards, forwards as well as downwards
- Movable forward horizontally up to 4 m
- Safe and convenient access from the ground

Low Noise Emissions

- High level of comfort for operators through insulated cabs
- Smooth diesel engines and electric motors mean lower noise emissions, making life more comfortable for operators both inside and outside the cab

Joystick with Proportional Control

- Good functionality with streamlined, ergonomic design
- 4-way mini joystick can be used to control all operations e.g. steering, outriggers and attachments etc.
- Joysticks – each with two newly designed buttons and a rocker switch – increase the number of functions available

Maintainability

Fast Service

Liebherr handling machines for port applications are powerful, robust, precise and efficient. They also have a service-focused machine design with integral maintenance benefits. All the maintenance points can be accessed easily and safely from catwalks and platforms and are easy to reach due to the large, wide-opening service doors.

Fast Maintenance

Maintenance work on handling machines can be carried out quickly, easily and safely due to the service-focused machine design. This minimises the handling machines' maintenance costs and down times.



Lubrication as it Works

- Fully automatic central lubrication system for uppercarriage and equipment
- Fully automatic central lubrication system for the undercarriage and attachments available as an option
- Lubricates without interrupting work to ensure better productivity and a long component service life

Excellent Service Access

- Large, wide-opening service doors
- Engine oil, fuel, air and cab air filters are easily and safely accessible on catwalks and platforms
- The oil level in the hydraulic tank can be checked from the cab
- Short service times for more productivity

SCRFilter for Stage V

- The SCR filter system developed by Liebherr includes a DOC catalyst, an SCR catalyst and an SCR-coated particulate filter
- The DOC catalyst requires no maintenance and the coated particulate filter is regenerated passively
- The maintenance intervals can be extended to more than 4,500 operating hours
- The maintenance intervals are even longer for machines with an electric motor

Alternative Drive Concept

Advanced Technology

Electrically powered handling machines from Liebherr are supplied as standard with a frequency converter. This guarantees the flexibility required by the electric motor to suit the job in hand. As a result of its function as a speed regulator, it enables sensitive, dynamic work movements to be performed and combines precision with speed.

The zero emissions drive concept, which also features a low noise level, is particularly suited to jobs in urban areas.

Perfect Working Conditions

The standard auxiliary air conditioning system delivers a pleasant climate for the cab regardless of the ambient conditions. This function is delivered independently of the main motor and is available to the operator at all times.

High Machine Availability

Long maintenance intervals and the elimination of daily work such as re-fuelling ensures that electric material handling machines deliver a high level of availability when used at ports.



Frequency Converters

- Individual adjustment of speed
- Soft start to prevent switch-on current peaks when starting
- Simple adjustment to all conventional power supply networks around the world

Innovative Drive Concept

- Electric motor for powerful, dynamic work movements
- Additional electric motor for secondary consumers delivers targeted power distribution and maximum energy efficiency
- Zero emissions and low noise levels

Low Maintenance Requirement

- The handling machines have high availability values as jobs such as refuelling and changing the engine oil are no longer required
- No replacement of diesel wearing parts required, such as fuel filters

Ports Never Sleep

The Services you need from Liebherr



Saving Time – Hand in Hand to Find the Perfect Solution

Do you want to maintain and service your handling machines yourself? Do you want to get everything ready quickly and flexibly on the evening for your next job, the next ship you have to unload?

The documentation available online and the spare parts shop in MyLiebherr enables you to access all the information you require with just a few clicks. Use our sophisticated logistics for fast deliveries of the parts you require, all in genuine quality of course. That will enable you to work efficiently. And if you're not sure what to do next, our experts are just a phone call away.

Transparency – Fleet Management and Modular Maintenance Systems

Are figures and the information they convey your strong point? Do you want to keep your running investments under review at all times and ideally be able to calculate in advance how much unloading a ship will cost?

Our LiDAT fleet management system supplies you with valuable information about your machine use and its fuel consumption. Liebherr's modular CarePacks are tailored to your needs to show you in advance precisely what costs you can expect to ensure that your machine will continue to perform at its best in the future. Our Reman Program also provides you with smart, low cost solutions for your older machines.

Reliability and Support – for Decision-Makers and Easy Planning

Are you not just interested in short term success, you want to be successful in the long term? Do you regard success not just as turnover, but also satisfied customers and helping to protect resources?

Our dense service network delivers consistency and a basis for planning, today and in the future. If necessary, our experts

are available for you 24/7. Our genuine parts and service experts ensure that your machines retain their value. Our LiDAT fleet management system delivers all the main machine data you need to assure your financial success and our Reman Program not only saves you money but also preserves valuable resources.

A selection of our services for you:

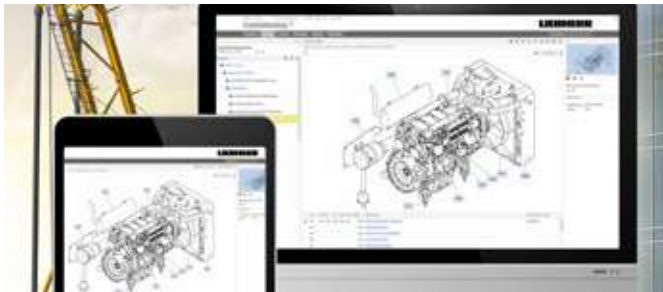

MyLiebherr Portal

In the workshop, on the road or even at the weekend at home, the MyLiebherr portal provides you with the latest machine documentation and spare parts catalogue whenever and wherever you need them. Order the items conveniently and easily using the online shop.



CarePacks

Investments which can be clearly calculated and advance machine planning – all this is made easy by our modular CarePacks. That leaves you to concentrate exclusively on your work.



A Strong Partner

The safe feeling of having a strong partner by your side. If necessary, our service experts are available for you 24/7. Every minute counts – particularly when working in a port, so short delivery distances are ideal.



Reman Program

The same performance and quality as a new part whilst reducing costs – that is what the replacement parts in our Reman Program deliver. An ideal solution, particularly for older machines, and at the same time you are helping to protect valuable resources.



Fleet Management System

When working at a port, you need to keep a clear head. LiDAT delivers all the relevant machine data such as scheduled service work, capacity use and much more at a glance.

For further information, services and contact details, go to:



Other Liebherr Machines for Port Applications

Wheel Loaders

Liebherr L 507 Stereo – L 586 XPower® wheel loaders are used at ports for transporting goods, unloading ships and loading trucks and goods trains.

They feature fast work cycles, high tipping loads and high machine availability. The innovative drive concepts used on Liebherr wheel loaders reduce fuel consumption by up to 30%. At maximum handling capacity, this reduces running

costs and increases profitability. Their compact design and fantastic manoeuvrability enable Liebherr wheel loaders to deliver maximum performance even in constricted spaces on land or in cargo holds. In addition, their simple operation ensures that they can be used with particularly high safety, sensitivity and precision.



Crawler Tractors

Liebherr crawler tractors are used for loading and unloading goods in cargo holds and for moving loose goods onto heaps. Liebherr PR 716 and PR 726 models have an operating weight of up to 20 tonnes, which means that they can easily be hoisted into the inside of a ship to provide effective support for loading vessel sizes from Panamax to Cape-size. Thanks to their robust crawler drive and the unbeatable

manoeuvrability of their hydrostatic drive unit, the machines can operate with maximum efficiency on fine grain mineral material and on sticky, compressed goods such as soya and other foodstuffs. Excellent visibility with all-round LED lights and integral ROPS/FOPS in the cab demonstrate that the safety of personnel is paramount for Liebherr.



Mobile Harbour Cranes

Liebherr's series of mobile harbour cranes (LHM) includes seven different sizes with lifting capacities ranging from 42 to 308 tonnes. LHM cranes have been delivered in more than 100 countries worldwide. Liebherr mobile harbour cranes convince in all application areas. Their flexible range of applications comprises highly efficient container handling, bulk operations, the handling of scrap, general cargo and even

heavy lifts. Unique technical remarks as the optimized undercarriage concept, the hydrostatic transmission or the specially developed crane control make Liebherr mobile harbour cranes one of the most powerful equipment worldwide.



Reachstacker

The Liebherr reachstacker (LRS) is a firmly established part of freight and container handling. Its wide range of uses extends from sea and inland ports to intermodal terminals. The LRS features very low fuel consumption and impresses with its extraordinary manoeuvrability. Its hydrostatic single wheel drive unit gives the machine a unique level of mobility, whilst the outstanding all-round visibility from the cab ensures that

it is a joy to operate. In addition to the typical handling of containers and semi-trailers, the LRS can also be used to handle break bulk. Liebherr offers also a timber handling machine, the LRS 545 Log Handler.



The Liebherr Group of Companies



Wide Product Range

The Liebherr Group is one of the largest construction equipment manufacturers in the world. Liebherr's high-value products and services enjoy a high reputation in many other fields. The wide range includes domestic appliances, aerospace and transportation systems, machine tools and maritime cranes.

Exceptional Customer Benefit

Every product line provides a complete range of models in many different versions. With both their technical excellence and acknowledged quality, Liebherr products offer a maximum of customer benefits in practical applications.

Liebherr-Hydraulikbagger GmbH

Liebherrstraße 12, D-88457 Kirchdorf/Iller
 ☎ +49 7354 80-0, Fax +49 7354 80-7294
 www.liebherr.com, E-Mail: info.lhb@liebherr.com
 www.facebook.com/LiebherrConstruction

Liebherr-Werk Bischofshofen GmbH

Postfach 49, A-5500 Bischofshofen
 ☎ +43 50809 1-0, Fax +43 50809 11385
 www.liebherr.com, E-Mail: info.lbh@liebherr.com
 www.facebook.com/LiebherrConstruction

Liebherr-MCCtec Rostock GmbH

Liebherrstraße 1, 18147 Rostock
 ☎ +49 381 6006 5020
 www.liebherr.com, E-Mail: reachstacker@liebherr.com
 www.facebook.com/LiebherrMaritime

Liebherr-Werk Telfs GmbH

Hans-Liebherr-Straße 35, A-6410 Telfs
 ☎ +43 50809 6-100, Fax +43 50809 6-7772
 www.liebherr.com, E-Mail: lwt.marketing@liebherr.com
 www.facebook.com/LiebherrConstruction

State-of-the-art Technology

To provide consistent, top quality products, Liebherr attaches great importance to each product area, its components and core technologies. Important modules and components are developed and manufactured in-house, for instance the entire drive and control technology for construction equipment.

Worldwide and Independent

Hans Liebherr founded the Liebherr family company in 1949. Since then, the family business has steadily grown to a group of more than 130 companies with more than 48,000 employees located on all continents. The corporate headquarters of the Group is Liebherr-International AG in Bulle, Switzerland. The Liebherr family is the sole owner of the company.

www.liebherr.com

WARNING

This product can expose you to chemicals including lead and lead compounds, which are known to the State of California to cause cancer and birth defects or other reproductive harm.
 For more information go to www.P65warnings.ca.gov.

WARNING

Breathing diesel engine exhaust exposes you to chemicals known to the State of California to cause cancer and birth defects or other reproductive harm.

- ▶ Always start and operate the engine in a well-ventilated area.
- ▶ If in an enclosed area, vent the exhaust to the outside.
- ▶ Do not modify or tamper with exhaust system.
- ▶ Do not idle the engine except as necessary.

For more information go to www.P65warnings.ca.gov/diesel.