

R 9600

Generation 8

LIEBHERR

Mining excavator



Technologies

- Assistance systems
- Liebherr power efficiency
- Bucket filling assistant

Powertrain options

Liebherr: 2,700 kW (FCO, Tier 4f)
3,620 HP
Cummins: 2,500 kW (FCO, Tier 4f)
3,350 HP
Electric: 2,400 kW (50 Hz, 60 Hz)
3,220 HP

Backhoe configuration

Overall weight: 633 tonnes
698 tons
Bucket payload: 68 tonnes
75 tons

Face shovel configuration

Overall weight: 645 tonnes
711 tons
Bucket payload: 67 tonnes
74 tons

Overview

R 9600

High performance execution

Patented EVO bucket



Diesel drive 2,700 kW / 3,620 HP
Electric drive 2,400 kW / 3,220 HP



BH 37.5 m³ / 49.1 yd³
FS 37.0 m³ / 48.4 yd³



BH 633 tonnes / 698 tons
FS 645 tonnes / 711 tons

Weight-optimised attachment

The R 9600 attachment makes use of smart component design such as the patented “EVO” backhoe bucket, hydraulic cylinders, shift levers, bucket links and attachment pins. The result is an increased overall production rate without compromising component lifetime.

Standard heavy-duty bucket

- Highest bucket capacity in its class with proven EVO bucket design
- Maximised payload with versatile Liebherr bucket solution
- Shift levers and bucket links with integrated greasing system

Perfect shovel truck match

- 4 pass loading of 240 tonne trucks
- 5 pass loading of 305 tonne trucks
- 6 pass loading of 375 tonne trucks



Latest cutting-edge technologies

Latest cabin generation

Sustainable & efficient performance

Latest cabin generation

- Increased comfort and ergonomics
- User-friendly operator station
- Suspended operator & trainer seats
- Slim line dash and ambient lighting
- Refrigerator and optional vacuum cleaner

Latest cutting-edge technologies

- Liebherr assistance systems
- Advanced machine monitoring with modern 7" and 15" touchscreens (day & night mode)
- 270° vision system with large dedicated 15" monitor

Sustainable performance

- US EPA Tier 4 / EU Stage V compliant engine
- SCR after-treatment technology
- Serial implementation of Liebherr power efficiency solutions
- Electric drive version

Performance & sustainability

Powertrain

+40 %
Fuel efficiency





Diesel drives

The R 9600 can be fitted with two versions of diesel drive systems. Customers can choose between the Liebherr D9812 and the Cummins QSK50 engine, both providing superior performance for increased productivity.

Liebherr 2x D9812

2,700 kW / 3,620 HP at 1,500 RPM
12 cylinder V-engine
Displacement 62 l / 3,786 in³



Cummins 2x QSK50

2,500 kW / 3,350 HP at 1,800 RPM
16 cylinder V-engine
Displacement 50.3 l / 3,067 in³



US EPA Tier 4 / EU Stage V

Both engines use selective catalytic reduction technology to comply with latest emission regulations the R 9600 combines flexibility to meet customer expectations without compromising productivity.



Electric drive

Liebherr offers an alternative to diesel engines allowing customers to balance performance with environmental consciousness. Building on 30 years' experience in electric drive excavators, the electric drive option allows lower maintenance costs and reduced noise pollution. With high motor efficiency, the electric drive gives maximum performance.

- Lower maintenance costs
- 6,000 V (other voltage on request)
- Integrated design elements on all machine structures
- Optional cable reeler

No exhaust emission

Liebherr electric R 9600 provides class leading cycle times using electric motors without exposing people and the environment to diesel exhaust emissions. Complying with all Non Road Mobile Machinery (NRMM) emission regulations, the R 9600 E can be operated all around the world.

Less noise level

Liebherr electric driven machines can be operated without restrictions in noise sensitive areas.



Productivity

Attachment

Setting new standards
in the mining industry

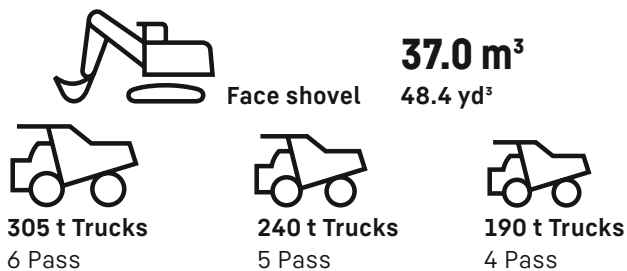
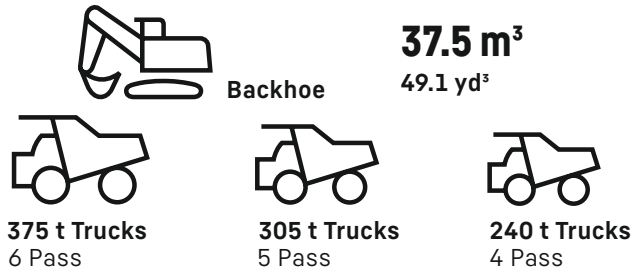

Smart component design

The optimised design of the R 9600 attachment increases the overall productivity without compromising component lifetime.

Maximised payload

Designed for best force distribution, the attachment design delivers high digging and hoisting forces, which ensures maximum payload during each cycle. The EVO bucket allows the operator to take advantage of each pass and therefore increase productivity.

Optimised cost per tonne

Built to outperform all competitors in the 600 t class, the R 9600 offers superior durability through its brand new machine and component design, delivering state-of-the-art capabilities and reliability.



+15 %
Productivity



"The R 9600 guarantees optimal force transmission."

Automation

Bucket filling assistant

The first automation product of the Liebherr hydraulic excavator portfolio allows easier bucket filling and consistent bucket fill factors, especially in blocky or hard digging conditions. As a result overall productivity improves while operator's fatigue decreases.



Anti-stalling function

Prevents the bucket from being stalled during the digging phase.



Semi-automatic bucket filling function

Allows the machine electronic to realise fully automatic attachment movements.



Discover more.

Comfort Operator cabin

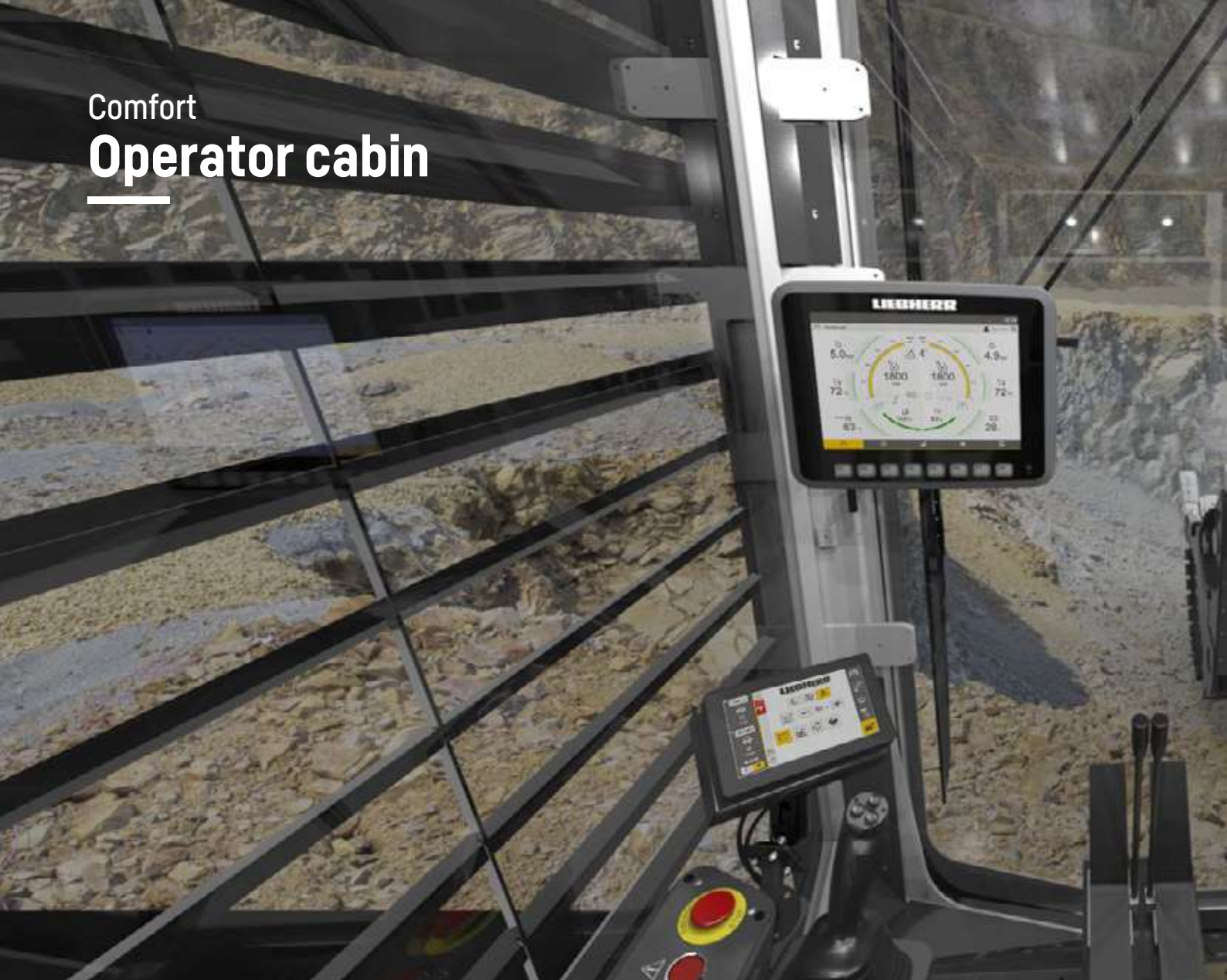

Latest cabin generation

- Spacious interior
- Modern and large touchscreens
- Indirect ambient LED lights
- Drawer refrigerator
- User-friendly piloting station
- Best in class visibility



Superior comfort

- Only 69 dB noise level
- Suspended and heated seats
- Synthetic leather interior
- Pressurised A/C system (single or double)
- Reading spotlights with tablet
- Phone and cup holders

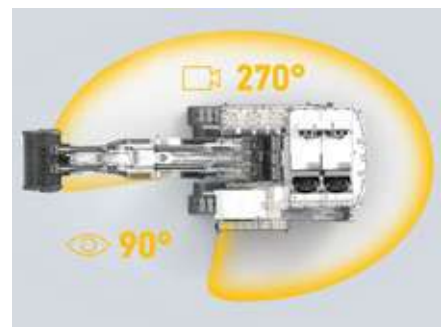

Vision system

The R 9600 offers superior visibility of the machine's surroundings. The dedicated monitor inside the cabin provides continuous 270 degree vision around the machine, from the four cameras strategically fixed on the uppercarriage. The operator has 90 degrees of direct visibility in front of the cabin.



Visibility
+30%

Working environment

Operator comfort

Resiliently mounted, the cab design reduces vibrations and limits noise to provide a comfortable and safe workspace (FOPS). Standard ambient lighting ensures even at night a serene working environment.

Perfect working position

The slim line dash allows positioning of operator's seat as far left as possible providing best visibility of the working area.

Additional features

Dedicated mounting points for additional customer devices, modules or antennas.

First class cabin

Operator and trainer seats are air-suspended and heated offering a high level of comfort. Beyond these outstanding features, Liebherr offers as standard a 20 litre drawer refrigerator and an optional vacuum cleaner fitted directly into the cabin.

Optional

- Double A/C system
- Vacuum cleaner
- Premium cooled seats
- Four point harness
- HEPA filtration system

Assistance systems

The best performance. Easy.

Get the best out of your Liebherr mining excavator

Available today on the R 9600, the Liebherr assistance systems are advanced onboard applications designed to support operators to become more efficient through analytics and actionable insights. Systems will assist the operator to obtain optimal productivity and efficiency by providing realtime operational information.

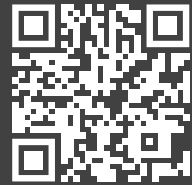

Want to live the real experience?



Measure and analyse every bucket payload for optimal truck loading



Data visualised within different views & advanced filtering



Display targeted productivity and actual payload with 99% accuracy



Provide transparency of performance, operating time and fuel efficiency



Identify operational conformance and improve operator effectiveness



State-of-the-art on-board touchscreen displays



Make informed decisions



Increase productivity

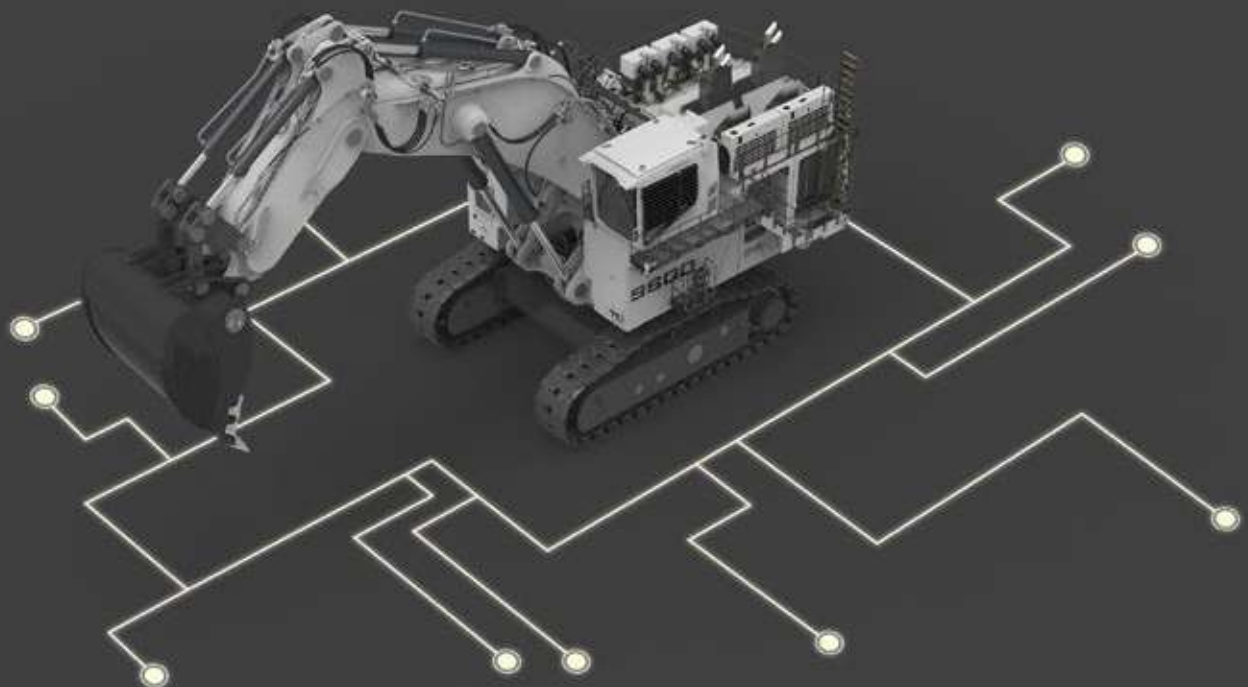



Truck loading assistant

Assists the operator to obtain target truck payloads.

With 99% measurement accuracy

- Measures instantaneously the bucket payload
- Provides real-time information to the operator
- Strategises the number of passes required
- Computes the best truck loading strategy
- Automatic truck recognition (optional)



Performance monitoring

Measures and analyses the overall performance.

Using KPIs, histograms and time-related charts

- Production KPIs
- Loading indicators
- Time distribution
- Energy efficiency



Application severity

Quantifies application, reports severity indicators and provides an overall application severity score.

KPIs to indicate and display the application as sensed by the machine

- Underfoot and digging conditions
- Abrasiveness and travel ratio
- Engine load factor and temperature variation
- Machine inclination, loading, etc.



Operational conformance

Detects and counts events to improve operator effectiveness.

Several filtering criteria to identify specific events

- Swinging into digging face
- Digging with swing brake activated
- Turning the machine with the attachment
- Bucket hitting track pads, etc.



Highest
digging force

1,560 kN

Breakout force

1,730 kN

in its class

Performance

Advanced hydraulic system

Fast & precise movement

Intelligent power management system

The Liebherr R 9600 mining excavator is equipped with a closed loop swing circuit. Kinetic energy is recovered when the swing motion is used during deceleration to drive the main and auxiliary pumps resulting in fuel consumption reduction. Cylinder dampening through IMUs provides smoother attachment movements without affecting attachment speed.

Independent cooling system

Oil and water cooling fans are independently and electronically managed. The oversized cooling systems reduce parasitic demand on engine horsepower ensuring maximum available horsepower is provided to the excavator working circuits.

New valve bank control system

- Under slung arch hoses to improve lifetime
- Flow optimized hose fittings
- Less hydraulic pressure losses by design
- Pilot valves integrated into valve blocks

Moving more with less

Patented Liebherr power efficiency

Specific engine and hydraulic management, drastically reducing fuel consumption without any compromise on machine productivity.

- Adapted piloting processes according to operator requirements and machine condition
- Electronically controlled pressure and oil flow
- Reduce hydraulic throttling and load profile of the engine for increased component lifetime

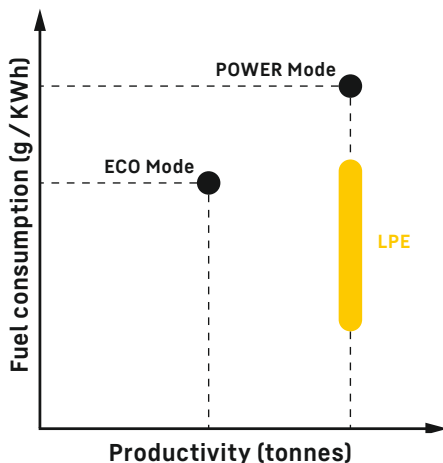

● Previous R 996B ● New R 9600 G8

Up to 20 % less fuel consumption

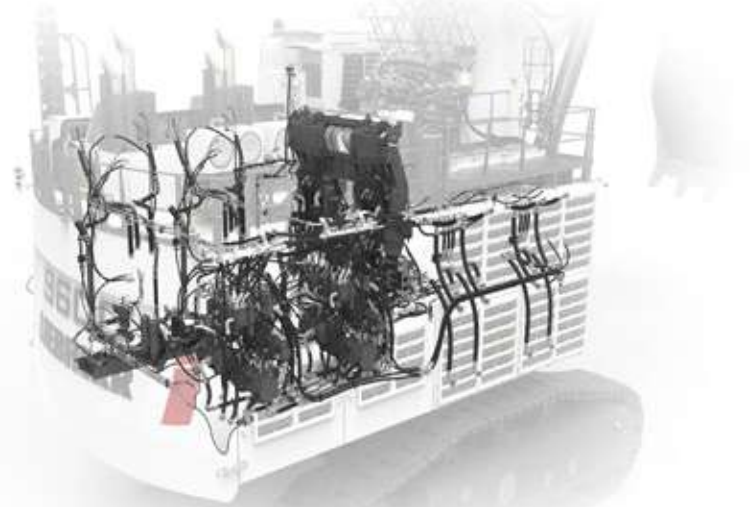

"Adapt the power and the hydraulic flow specifically to the load profile."

Safety

Protecting your most important asset



Machine accessibility

The R 9600 is fitted with an ergonomic hydraulically controlled 45 degree stairway with handrails, providing safe access to the upper-carriage.

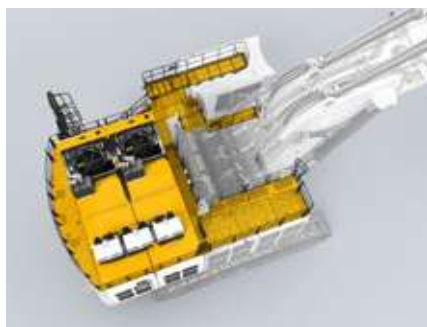

Wide catwalks for inspection

Enlarged walkways allow easy and safe access for inspection and maintenance around engines, fans, and pumps. All routine service items have been located to allow effortless inspection and replacement.



Emergency stops and emergency exits

Emergency stops are specifically located throughout the machine, increasing safety. A mechanical emergency egress guarantees safe and quick exit from the machine. An additional emergency drop down ladder is provided in the pump bay.



Advanced engine fire protection

After treatment systems and turbochargers are heat shielded. The engines are mechanically segregated from hydraulic components, further improving on machine safety.

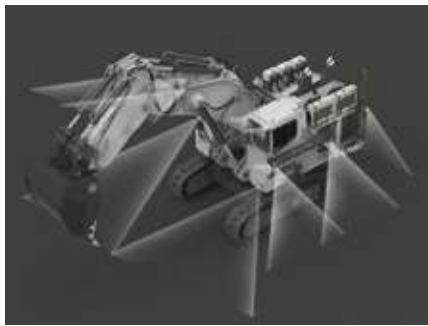

LED lighting system

Thanks to LED long-reach lights located on attachment, uppercarriage and counterweight, the machine offers best visibility to the operator and to the people/equipment around.



Safe surrounding area

Horn, LED working lights, LED service lights, LED access lights, flashing lights and travel alarm guarantee safe 24/7 operation and maintenance conditions.

Maintenance

Easy & safe operations

24/7
Operations



Centralised service

Service flap

Uppercarriage of the R 9600 has been designed for easier maintenance and quicker servicing. The central service area provides accessibility to uppercarriage fluid compartments

reducing machine downtime. Refill and separate drain points of the R 9600 are easily accessed from the ground with fast couplings and depressurised valves.

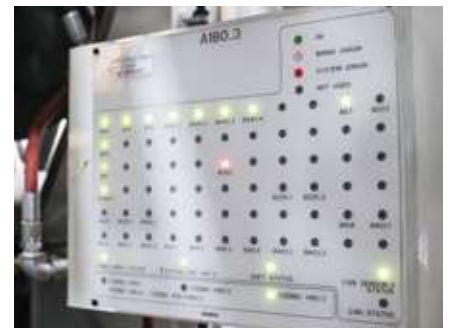
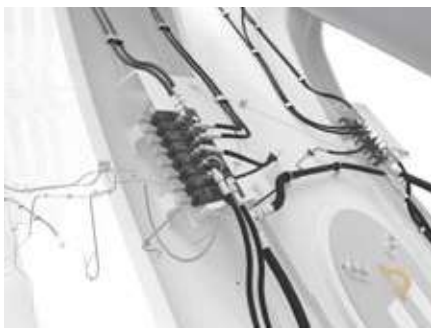

Automatic greasing system

- Grease tank for the attachment, uppercarriage and swing ring bearing
- Grease tank for the swing ring teeth
- Simplified component layout
- Automatic greasing cycles
- Reduced number of injectors & hoses
- Electric shut-off valve in the refill line

Superior engine accessibility

- Walkways all around the engines
- Service-friendly maintenance items installation
- Service interval 500 hours (Optional 1000 hours)
- Sampling-point for all liquids on deck

Ease of troubleshooting

- Signal panels
- Control system hardware and software completely developed and managed by Liebherr
- Reduced number of connections and connectors

Optional

- Service folding platform on front swing boxes
- Service doors on travel drive protection
- Additional Cummins oil reserve tank
- Banlaw or Wiggins couplings
- Kidney loop filtration system

Reliability

Long-lasting performances

Vertical integration

As an OEM, Liebherr has built a solid reputation for its development and production of high quality strategic mining components. The R 9600 integrates robust and reliable mining optimised components that are developed and manufactured by Liebherr, which ensures the best reliability and highest performance.

Mining know-how

Liebherr mining excavators are conceptualised, designed and dedicated to the mining industry. The engineering department uses specific 3D simulation solutions in order to meet possible requirements, such as finite element and fatigue life analysis.

80,000
Operational hours



Robust undercarriage

- Hydraulic track tensioning system
- Final drive with double lifetime sealing in series
- Fatigue resistant steel structure design
- Sealed for life heavy-duty carrier and track rollers
- Patented track pad design

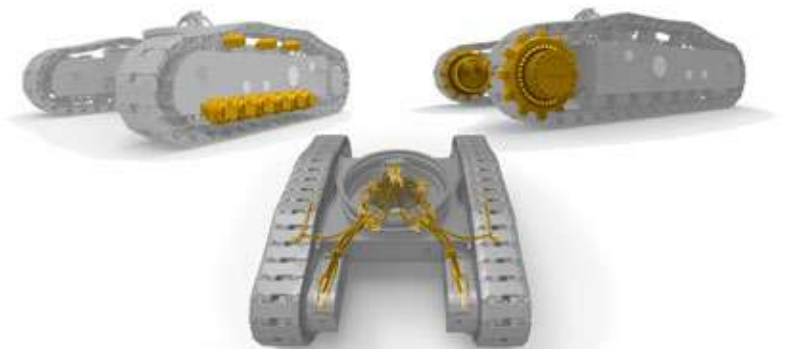



Super structure

- Complete new development
- Optimised welding penetration
- Increased structural rigidity and life
- Heavy duty conception through advanced 3D design and validation softwares



Quality: the Liebherr trademark

Providing reliable machinery is the highest priority for Liebherr mining. Utilised in tough mining applications all around the world, our R 9600 is built to last over 80,000 operational hours. Liebherr's engineering expertise and continuous improvement programs combine to deliver industry leading machines.

The four pillars of the Liebherr mining division

With more than 50 years of experience in the mining industry, Liebherr has identified four key factors of customer satisfaction: Performance, Safety, Service, and Sustainability. These pillars provide structure and focus for all our activities, and embody Liebherr's customer commitments.





Performance

Productive, efficient and reliable



Safety

Protecting your most important assets



Service

Where you need it, when you need it



Sustainability

Committed to our future



Technical data

Powertrain

2 Liebherr diesel engines	
Rating ECE-R.24 / ISO 9249	2 x 1,350 kW (2 x 1,810 HP) at 1,500 rpm
Model	Liebherr D9812 (US EPA Tier 4f / EU Stage V compliant or fuel consumption optimized setting)
Type	12 cylinder V-engine
Bore / Stroke	175 / 215 mm / 6.89 / 8.46 in
Displacement	62 l / 3,786 in ³
Engine cooling system	fans driven via hydraulic piston motors
Liebherr Power Efficiency – Engine Control	engine management systems adapting the power specifically to the load profile
Air cleaner	dry-type air cleaner with pre-cleaner, with automatic dust ejector, primary and safety elements
Fuel tank	14,067 l / 3,716 gal
Fuel filtration	3 stage fuel filtration with water separator and electric priming pump
Oil lubrication	spin-on filters and oil centrifuge filter
Electrical system	
Voltage	24 V
Batteries	8 x 180 Ah / 12 V starting battery 4 x 180 Ah / 12 V service systems
Alternator	24 V / 370 Amp
Engine idling	automatic engine idling
or	

2 Cummins diesel engines	
Rating per SAE J1995	2 x 1,250 kW (2 x 1,675 HP) at 1,800 rpm
Model	Cummins QSK50 (US EPA Tier 4f / EU Stage V compliant or fuel consumption optimized setting)
Type	16 cylinder V-engine
Bore / Stroke	159 / 159 mm / 6.26 / 6.26 in
Displacement	50.3 l / 3,067 in ³
Engine cooling system	fans driven via hydraulic piston motors
Liebherr Power Efficiency – Engine Control	engine management systems adapting the power specifically to the load profile
Air cleaner	dry-type air cleaner with pre-cleaner, with automatic dust ejector, primary and safety elements
Fuel tank	14,067 l / 3,716 gal
Fuel filtration	2 stage fuel filtration with water separator and electric priming pump
Oil lubrication	spin-on filters (4x)
Electrical system	
Voltage	24 V
Batteries	8 x 180 Ah / 12 V starting battery 4 x 180 Ah / 12 V service systems
Alternator	24 V / 260 Amp
Engine idling	automatic engine idling
or	

2 electric motor	
Power output	2 x 1,200 kW (2 x 1,610 HP)
Type	3-phase AC squirrel cage motor
Voltage	6,000 V, other voltage on request
Frequency	50 Hz (or 60 Hz)
Revolutions	1,500 rpm or 1,800 rpm
Motor cooling	integrated air-to-air heat exchanger
Starting method	inrush current limited to 2.2 full load current
Starting sequence	successive startup of electric motors

Electro-hydraulic controls

Servo circuit	independent, electronic over hydraulic proportional controls of each functions
Emergency control	emergency lowering of the attachment to the ground, via accumulators
Power distribution	via monoblock control valves with integrated primary relief valves, proportional and safety valves. Integrated secondary relief valves on functional blocks and motors
Attachment and swing	proportional via joystick levers
Travel	proportional via foot pedals
Electronic dampening system	Liebherr designed electronic control of cylinder position via inertial measurement units

Swing drive

Hydraulic motor	4 Liebherr axial piston motors
Swing gear	4 Liebherr planetary reduction gears
Swing ring	Liebherr, sealed triple roller swing ring, internal teeth
Swing speed	0 – 3.7 rpm
Swing-holding brake	4 hydraulically released, maintenance-free, external multi-disc brakes

Hydraulic system

Hydraulic pump	
for attachment and travel drive	8 Liebherr variable flow axial piston pumps
Max. flow	8 x 800 l/min. / 8 x 211 gpm
Max. pressure	320 bar / 4,641 psi
for swing drive	4 Liebherr reversible swashplate pumps, closed-loop circuit
Max. flow	4 x 530 l/min. / 4 x 140 gpm
Max. pressure	320 bar / 4,641 psi
Pump management	electronically controlled pressure and flow management with oil flow optimisation
Hydraulic tank capacity	5,425 l / 1,433 gal
Hydraulic system capacity	9,600 l / 2,536 gal
Hydraulic oil filter	1 high pressure safety filter after each main pump + fine filtration of the entire return flow (15 / 5 µm) dedicated leak-oil filtration
Hydraulic oil cooler	4 separated coolers with 3 temperature controlled fans driven via hydraulic piston motors
Liebherr Power Efficiency – Hydraulic Control	hydraulic management system adapting the hydraulic flow specifically to the load profile

Electric system

Electric isolation	easily accessible battery isolations (single isolation point)
Working lights	LED lights arrangement around the attachment and the upper-carriage
Emergency stop switches	at ground level, in engine and pumps compartment, at valve bank and in operator cab
Electrical wiring	heavy duty execution in IP 65 standard for operating conditions of -55 °C to 135 °C / -67 °F to 275 °F

Uppercarriage

Design	torsion resistant designed upper frame in box-type construction for superior strength and durability
Attachment mounting	parallel longitudinal main girders in box section construction
Machine access	45° access system with handrails on the cab side of the upper-carriage, full controlled descent in case of emergency stop. Emergency egress fitted near the cab and emergency ladder in the pump bay.

Cab

Design	resiliently mounted, sound insulated, large windows for all around visibility, integrated falling object protection (ISO 10262)
Operator's seat	suspended pneumatic seat, body-contoured with shock absorber, adjustable to operator's weight, additional suspended pneumatic passenger / trainer seat, seat heating
Cabin windows	tinted armored glass for front window and right-hand side window P5A (EN 356), all other safety windows tinted, high pressure windshield-washer system with 75 l / 20 gal watertank, sun louvers on all windows in heavy duty design
Heating system / Air conditioning	heavy duty, fully automatic, "plug & play" system, high output air conditioner and heater unit, contains fluorinated greenhouse gases HFC 134a with a Global Warming Potential (GWP) of 1430, the AC circuit contains 4.1 kg / 9 lb of HFCa-134 representing an equivalent of 5.9 tonnes / 6.5 tons of CO ₂ , the 2 nd AC circuit (optional) contains 4.1 kg / 9 lb of HFCa-134 representing an equivalent of 5.9 tonnes / 6.5 tons of CO ₂
Cabin pressurization	ventilation with filters, minimum pressurisation of 50 Pa (ISO 10263-4)
Controls	joystick levers integrated into armrest of seat, armrest adjusted to seat position
Display	15" machine touch panel for machine control and Liebherr Assistance Systems, 7" auxilliary touch panel for auxiliary / comfort control, 15" camera display
Condition monitoring	machine condition monitoring system with error reporting and operational information
Vision system	4 cameras providing 270° view
Safety functions	automatic engine shut off safety mode for engine speed control and pumps regulation
Noise level (ISO 6396)	Diesel: L _{pa} (inside cab) = 69 dB(A) Electric: L _{pa} (inside cab) = < 69 dB(A)
Hand-arm vibrations	≤ 2.5 m/s ²
Whole-body vibrations	≤ 0.5 m/s ²

Undercarriage

Design	3-piece undercarriage, box-type structure for center piece and side frames, stress relieved
Hydraulic motor	2 axial piston motors per side frame
Travel gear	Liebherr planetary reduction gear
Travel speed	Diesel : 0 - 1.7 - 2.2 km/h / 0 - 0.6 - 1.2 mph
Parking brake	spring engaged, hydraulically pressure released external wet multi-disc brakes for each travel motor, maintenance-free
Track chain	dual pin monobloc casted pads, maintenance-free
Track rollers / Carrier rollers	6 / 3 per side frame
Automatic track tensioner	pressurised hydraulic cylinder with accumulator, maintenance-free

Service flap

Design	hydraulically actuated service flap, easily accessible from ground level, including: <ul style="list-style-type: none"> - fast fuel refill line - hydraulic oil refill - engine oil exchange - splitterbox oil exchange - swing gearbox oil exchange (4 x draining / 4 x refill) - swing ring teeth grease barrel refilling with grease filter and shut off valve when high level reached - attachment / swing ring bearing grease barrel refilling with grease filter and shut off valve when high level reached - connection for windshield washer water refilling oil reserve system refilling (optional) - DEF exchange - coolant filling
--------	---

Central lubrication system

Type	single-line lubrication system for the entire attachment / swing ring bearing and teeth
Grease pumps	2 hydraulic grease pumps for attachment / swing ring bearing lubrication, 1 hydraulic grease pump for swing ring teeth
Capacity	600 l / 158.5 gal bulk container for attachment / swing ring bearing, separated 80 l / 21 gal container for swing ring teeth
Refill	via the service flap
Monitoring	via a specific Liebherr control module with data memory

Attachment

Design	box-type structure with large steel castings in all high-stress areas
Stick	wear protection underneath lower beam plate
Pivots	two floating pins per pivot, sealed covers, all bearings with wear resistant steel bushings, bolts hardened and chromium-plated
Hydraulic cylinder	Liebherr design, electronically controlled end-cushioning
Hydraulic connections	pipes and hoses equipped with SAE connections
Pivots bucket-to-stick Pivots bucket-to-link	O-ring sealed and completely enclosed
Lubrication	connected to the centralised lubrication system, each lubrication point independently lubricated

Dimensions

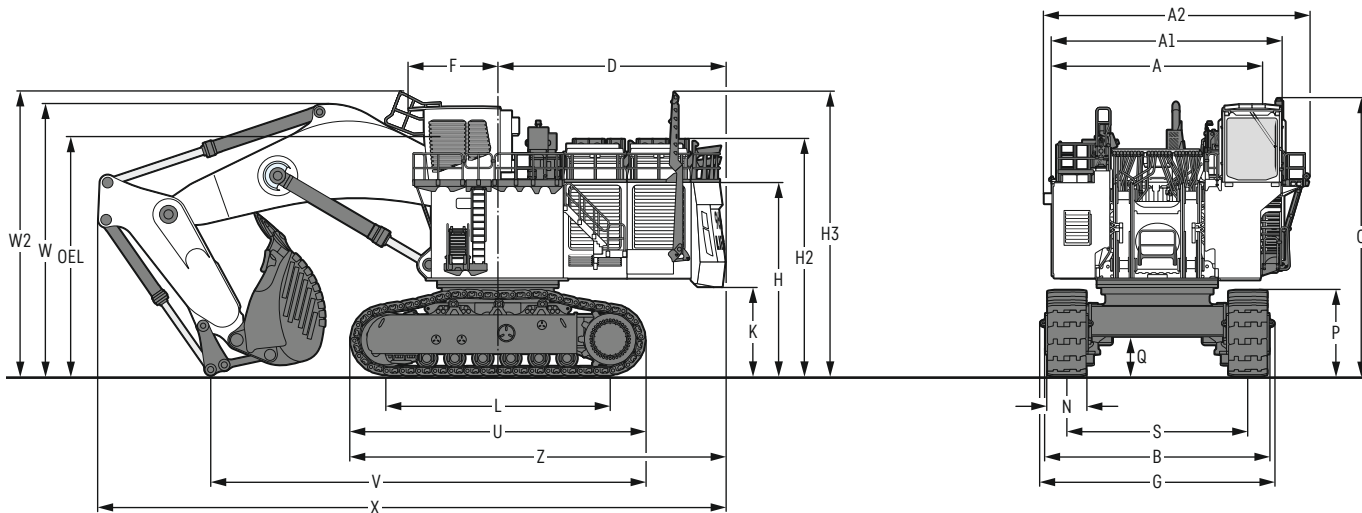

	mm / ft in
A	7,310 / 24'
A1	8,160 / 26' 9"
A2	9,220 / 30' 3"
B	7,870 / 25' 10"
C	9,610 / 31' 6"
D	7,950 / 26' 1"

	mm / ft in
F	3,331 / 10' 9"
G	8,175 / 26' 10"
H	6,760 / 22' 2"
H2	8,290 / 27' 2"
H3	9,980 / 32' 9"
K	3,100 / 10' 2"

	mm / ft in
L	7,850 / 25' 9"
N	1,350 / 4' 5"
P	3,010 / 9' 11"
Q	1,390 / 4' 7"
S	6,330 / 20' 9"
U	10,325 / 33' 10"

	mm / ft in
V	15,210 / 49' 11"
W	9,500 / 31' 2"
W2	9,950 / 32' 8"
X	21,950 / 72'
Z	13,100 / 43'
OEL (Operator's eye level)	8,360 / 27' 5"

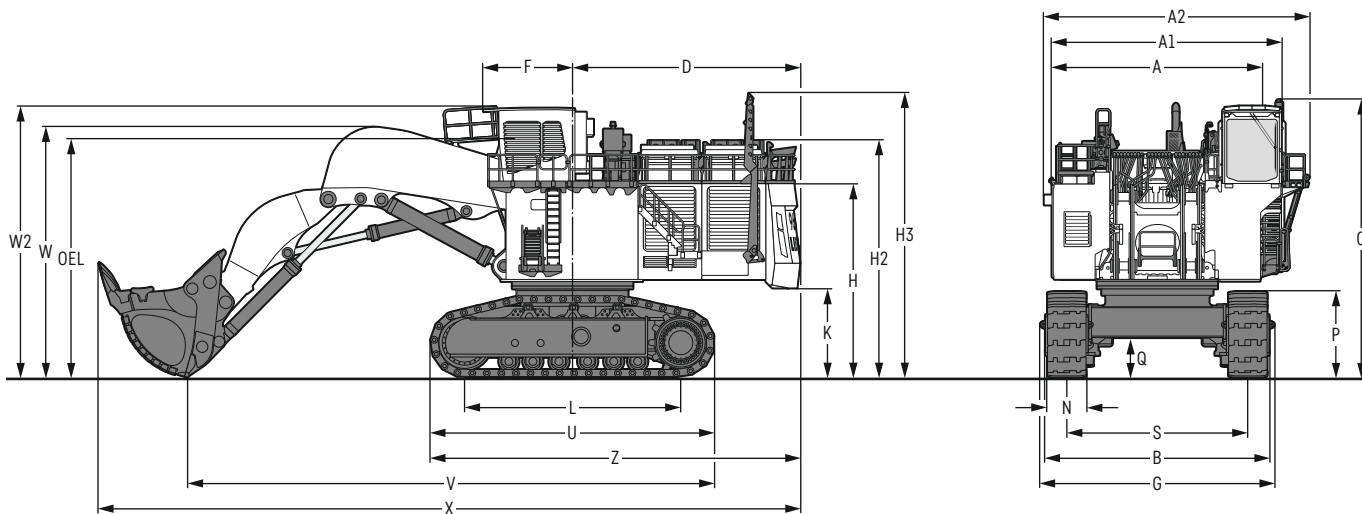

	mm / ft in
A	7,310 / 24'
A1	8,160 / 26' 9"
A2	9,220 / 30' 3"
B	7,870 / 25' 10"
C	9,610 / 31' 6"
D	7,950 / 26' 1"

	mm / ft in
F	3,331 / 10' 9"
G	8,175 / 26' 10"
H	6,760 / 22' 2"
H2	8,290 / 27' 2"
H3	9,980 / 32' 9"
K	3,100 / 10' 2"

	mm / ft in
L	7,850 / 25' 9"
N	1,350 / 4' 5"
P	3,010 / 9' 11"
Q	1,390 / 4' 7"
S	6,330 / 20' 9"
U	10,325 / 33' 10"

	mm / ft in
V	18,400 / 60' 4"
W	8,760 / 28' 9"
W2	9,500 / 31' 2"
X	24,530 / 80' 4"
Z	13,100 / 43'
OEL (Operator's eye level)	8,360 / 27' 5"

Backhoe attachment

with mono boom 10.90 m / 35'9"

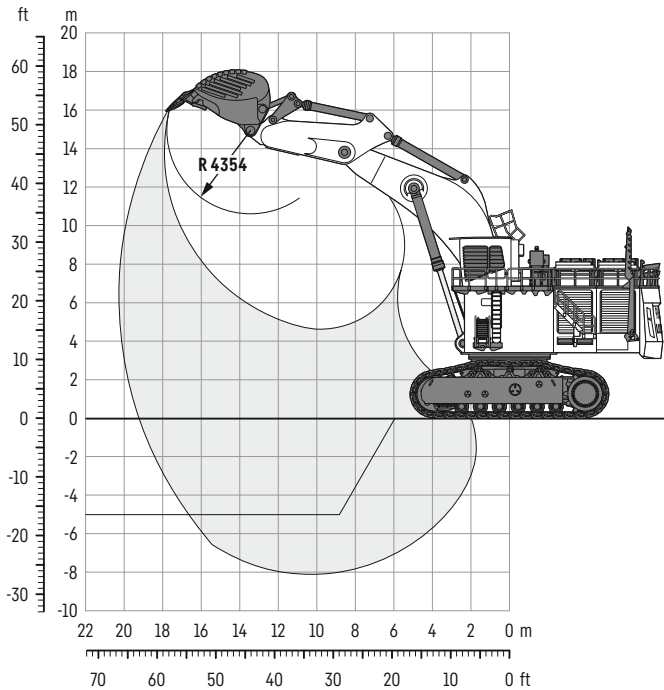

Digging envelope

Stick length	m	5.00
	ft in	16'5"
Max. digging depth	m	8.10
	ft in	26'7"
Max. reach at ground level	m	19.20
	ft in	63'
Max. dumping height	m	10.60
	ft in	34'9"
Max. teeth height	m	16.20
	ft in	53'2"

Forces

Max. digging force (ISO 6015)	kN	1,575
	lbf	354,074
Max. breakout force (ISO 6015)	kN	1,740
	lbf	391,168

Operating weight and ground pressure

The operating weight includes the basic machine with backhoe attachment and backhoe bucket 37.50 m³ / 49.05 yd³.

Pad width	mm	1,350
	ft in	4'5"
Weight	kg	633,000
	lb	1,395,526
Ground pressure*	kg/cm ²	2.69
	psi	38.26

* according to ISO 16754

Backhoe buckets

For materials class according to VOB, Section C, DIN 18300		3 - 4	5 - 6	5 - 6	7 - 8
Typical operation according to VOB, Section C, DIN 18300		GP	HD	HD	XHD
Capacity ISO 7451	m ³ yd ³	39.00 51.01	40.00 52.32	37.50 49.05	33.30 43.56
Suitable for material up to a specific weight of	t/m ³ lb/yd ³	1.8 3,035	1.65 2,782	1.8 3,035	2.05 3,457
Cutting width	mm ft in	4,800 15'8"	4,800 15'8"	4,600 15'1"	4,600 15'1"
Weight	kg lb	34,000 74,957	38,200 84,216	36,800 81,130	36,300 80,028

GP: General purpose bucket
 HD: Heavy-duty bucket
 XHD: Heavy-duty rock bucket

Other buckets for other densities and / or material classes on request

Face shovel attachment

with shovel boom 7.90 m / 25'11"

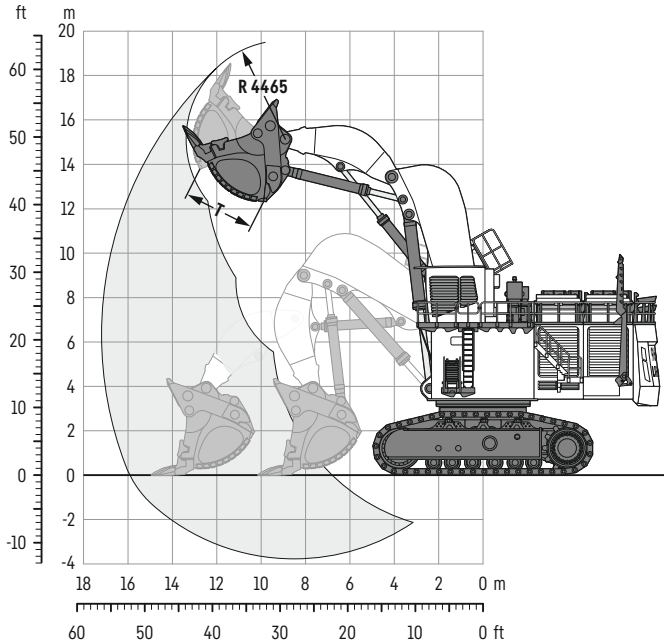

Digging envelope

Stick length	m	5.10
	ft in	16'9"
Max. reach at ground level	m	15.90
	ft in	52'2"
Max. dumping height	m	12.40
	ft in	40'8"
Max. crowd length	m	4.80
	ft in	15'9"
Max. teeth height	m	19.50
	ft in	64'
Bucket opening width T	m	3.20
	ft in	10'6"

Forces

Max. crowd force at ground level (ISO 6015)	kN	2,425
	lbf	545,162
Max. crowd force (ISO 6015)	kN	2,625
	lbf	590,124
Max. breakout force (ISO 6015)	kN	2,125
	lbf	477,719

Operating weight and ground pressure

The operating weight includes the basic machine with shovel attachment and bucket 37.00 m³ / 48.40 yd³.

Pad width	mm	1,350
	ft in	4'5"
Weight	kg	645,000
	lb	1,421,982
Ground pressure*	kg/cm ²	2.74
	psi	38.97

* according to ISO 16754

Face shovel buckets

For materials class according to VOB, Section C, DIN 18300		3 - 4	5 - 6	5 - 6	7 - 8
Typical operation according to VOB, Section C, DIN 18300		GP	HD	HD	XHD
Capacity ISO 7451	m ³	38.50	39.00	37.00	34.00
	yd ³	50.36	51.01	48.40	44.47
Suitable for material up to a specific weight of	t/m ³	1.8	1.65	1.8	2.00
	lb/yd ³	3,035	2,782	3,035	3,373
Cutting width	mm	5,200	5,200	5,200	5,200
	ft in	17'	17'	17'	17'
Weight	kg	61,000	66,000	63,900	62,500
	lb	134,482	145,505	140,875	137,789

GP: General purpose bucket
 HD: Heavy-duty bucket
 XHD: Heavy-duty rock bucket

Other buckets for other densities and / or material classes on request

Optional equipment

Undercarriage

Large track pads
Center girder lower cover plate
Swing ring scrapers

Uppercarriage

Steel grease lines on swing ring
Rock protection for fuel tank
Rock protection for hydraulic tank
Wiggins or Banlaw fast refilling systems
Coolant draining/filling from service flap
Additional RHS catwalks for windshield access
Automated sampling point
Additional fast fuel refill line

Hydraulic system

Oil cooler inlet screens
Kidney loop filtration system
Additional catwalks inside hydraulic tank

Powertrain

Tier 2, Tier 4f engine versions
Cummins oil reserve system

Cab

4-points seat belt
Premium cooled seats
Vacuum cleaner
Double A/C system
Front protective grid
Leatherette seats
Cabin pressurisation with HEPA filters

Automation

Bucket Filling Assistant

Specific solutions

Arctic package (-20 °C/-4 °F, -35 °C/-31 °F, -50 °C/-58 °F)
Sound attenuation package (until +40 °C/+104 °F)
High altitude package
Oil sand package

Safety

Automatic fire fighting system
Isolation & energy dissipation system - MDG 41 compliant
Service folding platform over front swing boxes
Starter inhibition from ground level
Fall restraint cable on boom (CE certified)
Fall restraint cable on boom (AS/NZL certified)

General

Maritime transport packaging
Delivery without batteries

Electric drive

Automatic cable reeler

Assistance systems

Truck Loading Assistant
Operational Analytics



Mining excavator



Mining truck



Mining dozer



Mining dragline



Service tools



Customer service

Quality commitment

- Liebherr-Mining Equipment Colmar, France, ISO 9001 certified
- Compliance of materials tested in laboratory
- Quality control during all stages of production
- CE certified, MDG 15 & MDG 41 compliant

Subject to technical modifications. All comparisons and claims of performance are made with respect to the prior Liebherr model unless specifically stated.

Liebherr-Mining Equipment Colmar SAS

49 rue Frédéric Hartmann • 68025 Colmar Cedex, France • Phone +33 369 49 20 00
info.lec@liebherr.com • www.liebherr.com • www.facebook.com/LiebherrMining